



STEEDE STAANDE,  
GESTUUR &  
GESEËND

STILL STANDING,  
SERVING &  
BLESSED



The Gideons  
International  
IN SOUTH AFRICA



STILL STANDING,  
SERVING & BLESSED

# *Steeds staande, gestuur & gesëend*

GETUIENISSE DEUR DIE JARE

Ter herdenking van 75 jaar van  
Die Gideons Internasionaal in Suid-Afrika



# *Still standing, serving & blessed*

TESTIMONIES OVER THE YEARS

In commemoration of 75 years of  
The Gideons International in South Africa

# INLEIDING

Sedert 1950 werk lede van Die Gideons Internasionaal in Suid-Afrika toegewyd aan die verspreiding van die Goeie Nuus. Die Gideons Internasionaal is 'n wêreldwye interkerklike organisasie van Christen sake- en professionele mans en hul vrouens wat hul roeping uitleef deur die verspreiding van God se Woord. Sedert die stigting in 1899, word Bybels en Nuwe Testamente in bykans 200 lande versprei, met die enigste doel om mense aan Jesus Christus voor te stel. Hierdie getuienisboekie vier

75 jaar van God se getrouheid en herinner ons aan die talle lewens wat geraak is deur die bediening se kernwerk: Die wen van siele vir Jesus Christus.

Elke verhaal in hierdie boekie beklemtoon die diepgaande impak van individuele dade van geloof en gehoorsaamheid. Van 'n Moslem-onderwyser wat die Christendom in 'n klaskamer omhels tot 'n man in die tronk wat verlossing vind, beklemtoon hierdie getuienisse die krag van God se Woord om lewens te transformeer. Soos 2 Korintiërs 5:17 ons herinner: **“Iemand wat**

**aan Christus behoort, is 'n nuwe mens. Die oue is verby, die nuwe het gekom"** (AFR83). Dit dien as 'n kragtige herinnering dat elke Bybel wat geplaas word en elke persoonlike gesprek kan lei tot 'n wonderbaarlike ontmoeting met Jesus, wat ons roeping versterk om "Steeds Staande, Gestuur en Geseënd" te wees.

Indien jy, as leser, op enige manier betrokke wil raak of meer inligting verlang, kan jy gerus Die Gideons Internasionaal in Suid-Afrika kontak soos uiteengesit aan die agterkant van hierdie boekie.

# *Inhoudsopgawe*

- 6 Dit is waaroor Kersfees gaan
- 7 'n Wonderwerk in die klaskamer - *Elmarie du Plessis*
- 8 Versprei die boodskap van Geloof - *Kuben Moodley*
- 9 Dankie Here, dat U vir my gesorg het - *Ettorina Stoop*
- 10 George ramp, Bybelplasing - *Pierre le Grange*
- 11 Koeël deur Bybel gekeer
- 12 Wees gehoorsaam en beskikbaar - *Sunette le Grange*
- 13 Reis na die ewige lewe - *Shaun Makgetla*
- 14 Die woord en 'n wonderwerk – 'n Bybel, geplaas deur Die Gideons, langs 'n hospitaalbed
- 16 Generaal Jorge Da Cronha Vungulipi - *Christo Fourie*
- 17 Wees bereid om te dien en beskikbaar te wees - *Sarieta Wentzel*
- 18 'n Pragtige boek - *Kuben Moodley*
- 19 Geseënde plasing - *Peet Van Der Merwe*
- 20 Die ou dinge het verbygegaan - *Johan Boshoff*
- 22 Getuienis: Da Gama poliseselle - *Oscar Ehrensperger*
- 23 Bemagtig ander mense om siele te wen - *Sonna Kitching*
- 24 Die werk van die Heilige Gees - *Peet Van Der Merwe*
- 25 In tye van nood - *Koers Fourie*
- 26 Getrou in Turkye
- 27 Getuienis van AJ Wohlfahrt 2023 - *A.J. Wohlfahrt*

- 28 Gedra deur gebed - *Diederik Esterhuizen*
- 30 God is genadig - *James Milson*
- 31 Gered van selfmoord
- 32 God is getrou - *Johan Bruwer*
- 33 Van motorwag tot kerkplanter - *Corné en Anita de Jager*
- 34 Baie meer as net kos - *Anita de Jager*
- 35 God gebruik ons waar ons is - *Leana Mostert*
- 36 Goeie nuus afgelewer
- 37 Hier is ek Here, gebruik my! - *Robert en Louise York*
- 38 Getuienis ISB 2025 - *Patience Makiwa*
- 39 Laaste PWT
- 40 Moedersdag 2022 - *Esta Putter*
- 41 Loof God vir die ISB in Suid-Afrika - *John Mannen*
- 42 Die Here voorsien altyd... - *Johann en Marguerite Minnaar*
- 43 Die antwoord is Gebed - *Kuben Moodley*
- 44 'n Pienk fout... of 'n Goddelike afspraak? - *ISB Umhlanga span*
- 46 God se goedheid in Ghana - *Lieb Venter*
- 47 'n Jesus oomblik in Portugal - *Awie Thomas*
- 48 Raak lewens aan - *Heidie van den Berg*
- 50 Om 'n groot vis te vang in Mauritius - *Derrick Kuun*
- 52 *English version*

*Dit is waarom*

## **KERSFEES GAAN**

Gedurende 2022 het Tygerbergtak in die Kaap Metro-area van streek 1 deel geword van die broederskap in Goodwood met 'n maandelikse vergadering en 'n weeklikse gebedsgeleentheid. Die demografie van Goodwood het aansienlik verander en ons is 'n mengelmoes van kulture, wat baie opwindend is.

Die SAPD van Goodwood is ook aktief betrokke by hierdie geleentheid. Die aeadirekteur dien ook op die Geestelike Misdaadvoorkomingseenheid van Goodwood SAPD. Die SAPD het die behoefte uitgespreek dat die plaaslike Gideons hul moet kom bedien. Hulle soek ook mense wat 'n polisie agtergrond-ondersoek en keuring kan ondergaan om by die Goodwood gevangenis te gaan bedien.

Die hoogtepunt van die jaar kan wees wanneer Die Gideons 'n geleentheid het om die gevangenes om 06:00 op Kersoggend te gaan bedien. Hierdie is 'n uitdaging aan al die takke in SA. Dit kan iets wees wat Die Gideons reg oor ons land kan doen, al hou jy vakansie iewers.

*Dit is waarom Kersfees gaan: God wat medelye met ons gehad het en Sy grootste geskenk vir ons gegee het. Leef dankbaarheid uit in die Kerstyd! Gryp elke geleentheid aan om tydens die Kersseisoen die goeie nuus van God se liefde te deel.*

# 'n Wonderwerk

## IN DIE KLASKAMER

Tydens die onlangse Internasionale Bybelblitz in KwaZulu-Natal het ons by nóg 'n klaskamer ingestap om Nuwe Testamente aan elke skoolleerder uit te deel. Die skoolhoof het ons toestemming gegee om van klas tot klas te beweeg.

By die betrokke klas was die onderwyser afwesig toe ons aankom. Net toe ons wou begin, het die onderwyseres opgedaag. Sy was geklee in tradisionele Moslemdrag, met slegs haar oë sigbaar.

Gedagtes van moedeloosheid het by ons opgekom - ons het verwag dat sy ons dalk nie in haar klas sou toelaat nie. Tot ons verbasing was sy egter vriendelik en het ons toestemming gegee om aan elke kind 'n Testament uit te deel.

Die Gideon het begin met sy aanbieding en het ook die blou gedrukte bladsye, agter-in die Testament, aan die leerders uitgewys. Ek het sonder huiwering na die onderwyseres gestap en ook vir haar 'n Testament aangebied. Terwyl die Gideon die "Weg na Saligheid" agterin die Testament met die leerders bespreek het, het ek dieselfde met haar gedoen. Sy het die Testament in haar hande geneem en die blou bladsye saam met my gevolg.

Na die aanbieding is die leerders uitgenooi om die "sondaarsgebed" hardop te bid – en tot my verbasing het die Moslem-onderwyseres dit hardop saam met hulle gebid. Ek het my oë (onder gebed) oopgemaak om seker te maak ek hoor reg... en ja, sy het die hele gebed saam gebid!

Dankie Jesus! Dankie vir hierdie wonderwerk!

**Elmarie du Plessis**  
Ghaaptak



*Versprei die*

# BOODSKAP VAN GELOOF

Ek en my vrou, Jennifer, het onlangs die wonderlike geleentheid gehad om Egipte te besoek. Hierdie reis was ons eerste internasionale reis as Gideons, en ons was gevul met 'n mengsel van opgewondenheid en vrees. Gewapen met onwrikbare geloof in die teks van Matteus 28:19, wat ons beveel om “te gaan en dissipels te maak van al die nasies”, en toegerus met Persoonlike Werkers Testamente (PWT'e), het ons gretig ons avontuur aangepak.

Ons het geleer dat ongeveer 20% van die Egiptiese bevolking ons geloof deel en daar was 'n gevoel van konneksie toe ons 'n PWT met iemand in hul eie taal en in hul eie vaderland gedeel het. Ek kon die PWT-plasings op die GideonGO App aanteken en het die vaardighede geoefen wat ek verwerf het by die **“Gideons Conversation”** kursus.

Teen die einde van ons reis het ons 47 PWT'e geplaas, wat in Engels, Arabies, Frans en Chinees beskikbaar was. Ons het ons voorraad PWT'e uitgeput, en toe die **GideonsGo App** begin deel. Elke persoon wat die App afgelaai het, het 'n soortgelyke en vreugdevolle reaksie beleef toe hulle die Bybel in hul moedertaal gehoor het.

Ons gee alle lof en eer aan God vir al die deure wat Hy vir ons oop gemaak het asook vir 'n werklik lonende en onvergeetlike reis waar ons die missie van Die Gideons kon vervul en die boodskap van geloof oor taal- en kultuurgrense kon versprei.

**Kuben Moodley**  
Randburgtak

# *Dankie, Here,* **DAT U** **VIR MY GESORG HET**

Die Colesbergtak het ons skool besoek vir die jaarlikse Bybelplasing. Nadat Die Gideons weg is, het die Graad 8-leerders vir twee periodes in my klas gebly, te besig met hul nuwe Bybels vir my om te onderrig. Hulle het gretig vir verskillende verse gevra en tyd spandeer om te lees. Ek het glad nie omgee nie – hulle was ten minste besig om hul nuwe geskenk te verken.

Ons skool sluit leerders van verskeie gelowe in, insluitend Moslem-studente. Ek bid openlik wanneer die skool begin, oor die kos wat hulle ontvang, en aan die einde van elke dag. Hulle weet ek is nie skaam om 'n Christen te wees nie. As ek oor my lewe nadink, sien ek hoe God my in talle situasies beskerm het. As ek terugkyk, sien ek net een stel voetspore.

Dankie, Here, dat U vir my gesorg het. Wat 'n eer om vir ons Here Jesus te werk. Dit is baie spesiaal.

**Ettorina Stoop**

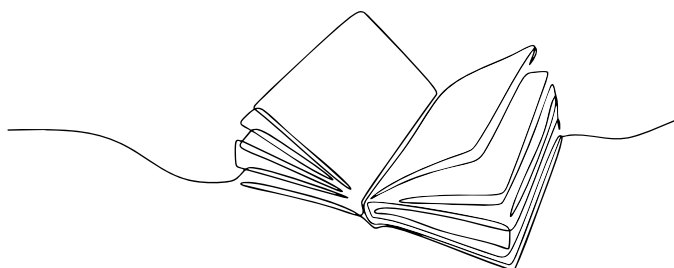

# George ramp

## BYBELPLASING

Die Bybelplasing by die ramptoneel in George na die gebou op 6 Mei 2024 ineengestort het, het plaasgevind soos beplan. Die stemming was maar morbied. Dit is 'n groot uitdaging, want daar word gesukkel om liggame uit te ken. Dit bring groot onsekerheid en veroorsaak trauma vir families elke keer as 'n liggaam gevind word.

Ons het die geleentheid gehad om saam met familieledede in groepies te bid en Nuwe Testamente aan hulle te oorhandig. Bongani, die broer van 'n vasgekeerde werker, het sy hart vir Jesus gegee, prys die Here. Ons kon daarna saam met almal bid, insluitende die ondersteuningspan wat die families ondersteun. Ons het ook met die ondersteuningskoördineerder van die reddingswerkers en sy span gebid. Hulle voorsien ondersteuning, van kos tot berading-behandeling. Ons kon ook vir hulle voedsel vir die geestelike voorsien deur Testamente te plaas. Ons het 280 Nuwe Testamente in vyf tale geplaas.

Aan Vader al die eer!

**Pierre le Grange**

Mosselbaaitak

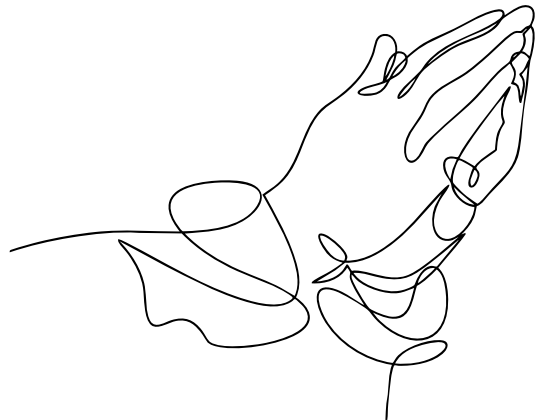

*Koeël deur*

## **BYBEL GEKEER**

In 1899 besef 'n man dat die mens God se Woord nodig het en in 1809 begin hulle Bybels plaas. So het Die Gideons-organisasie tot stand gekom. Ek het ook aan die begin van my weermagdiens 'n rooi Bybeltjie van Die Gideons-organisasie ontvang.

Vandag is daar Gideons in 199 lande wat hulle tyd en geld gee om ander mense die kans te gee om te leer oor die liefde van God deur Bybels oor die hele wêreld uit te deel.

'n Engelsman met die naam van Frederick Peil was 'n slagter wat in 1917 aangesluit het by die weermag om in die Eerste Wêreldoorlog te veg. Hy was bekend omdat hy altyd 'n Bybeltjie in sy bo-sak gedra het. Een dag, terwyl hulle in 'n aanval betrokke was, het 'n Duitse masjiengeweer se koeël hom getref – reg op sy hemp se linkersak, waar sy Bybeltjie was.

Die koeël is deur die Bybeltjie gekeer en het heel waarskynlik Frederick se lewe gered. Letterlik!

Mag ons almal erns maak met ons roeping, seker maak waar ons gawes is en waar die Vader wil hê ons moet dit gaan uitleef. Mag ons so in die wêreld leef dat baie ander die koeëls van die lewe gespaar word.

Met erkenning aan Gerjo Ben – geplaas op sosiale media.

*Wees gehoorsaam*

## **EN BESKIKBAAR**

Ek het na my kleinseun omgesien toe my dogter weer begin werk het en ek het een dag met hom in die tuin gaan stap. Die tuinier het in die groentetuin gewerk, en ek het met hom begin gesels. Die Heilige Gees het my gevra om hom te vra of hy 'n Testament sou wil hê. Sy uitdrukking van vreugde en geluk toe hy die Testament ontvang, sal my altyd bybly.

David is nog 'n siel wat vir die Koninkryk gewen is. Mag ons getrou gevind word dat ons ywerig sal wees in die roeping om die Goeie Nuus te versprei.

**Sunette le Grange**

Mosselbaaitak

# *Reis na die*

## **EWIGE LEWE**

Ek, Ben Fourie en Guston Isaacs het die evangelie gedeel en Bybels aan die gevangenes versprei. Ek het my getuienis openlik met al die gevangenes gedeel en beskryf hoe my lewe van ellende na hoop verander het nadat ek Christus ontvang het.

Ek het vertel van naby-dood-ervarings as gevolg van bendegegeweld en dwelmmisbruik, en hoe God my lewe heeltemal vernuwe het toe ek my aan Hom oorgegee het. Almal het na my geluister asof hulle kon visualiseer waardeur ek gegaan het. Onder hulle was Whitey, 'n man wie se lewe daardie dag vir altyd verander is.

Met trane in sy oë het Whitey vorentoe gestap, asook ander wat hul lewens aan Jesus Christus oorgegee het. Hulle het openlik hulle sondes bely en Christus as hulle Here en Verlosser aangeneem. Die transformasie was tasbaar.

Net twee dae later is Whitey oorlede, maar hy kon 'n erfenis van geloof en verlossing nalaat. Alhoewel sy tyd by ons kort was, het sy besluit ewige implikasies gehad.

Ons is bly omdat ons weet dat Whitey nou in die teenwoordigheid van sy Verlosser is, vry van pyn en lyding. Sy verhaal inspireer ons om die evangelie met dringendheid en deernis te deel.

Aan God kom die eer toe vir die wonderbaarlike transformasie in Whitey se lewe.

**Shaun Makgetla**

Welkomtak

*Die woord en 'n  
wonderwerk –*

# **'N BYBEL, GEPLAAS DEUR DIE GIDEONS, LANGS 'N HOSPITAALBED**

Die aand van my geboorte is ek aan die een kant van my liggaam verlam gebore. My ma, wat toe 42 was, was verpletter omdat haar baba so gebore is. Sy is ingelig dat ons vroeg die volgende oggend na die neurologiese afdeling van 'n hospitaal in die stad sou moes vlieg.

Daardie aand het my ma na die Bybel, geplaas deur Die Gideons, langs haar hospitaalbed gegryp en het sy God 'n baie spesifieke vraag gevra: “Wat gaan van hierdie kind word?”

Toe sy die Bybel oopmaak, het haar oë op die profesie van Johannes die Doper se geboorte geval. In Lukas 1:66 (AFR83) lees sy:

**“Wat gaan dan van hierdie kind word?’ Want dit was duidelik dat die hand van die Here met hom was.”**

Deur hierdie vers het my ma se geloof toegeneem en sy het God gedank, die Bybel toegemaak en rustig gevoel.

Vroeg die volgende oggend het 'n rooikopverpleegster my na my ma gebring en gesê: “Kyk, 'n wonderwerk! Dit gaan goed met jou baba, haar ledemate beweeg en reageer!”

Ons dank Die Gideons Internasionaal in Suid-Afrika, wat Bybels getrou in hospitale versprei.

Later in my lewe was ek in 'n motorongeluk, en vir die eerste keer moes ek X-strale van my rug kry.

In die Noodgevalle het die dokter gevra wanneer ek 'n ruggraatfusieoperasie ondergaan het.

Ek het hom gesê ek het nog nooit 'n operasie gehad nie, toe vra hy my man. My man het geantwoord: “Lig haar hemp op; daar is geen chirurgiese littekens nie.”

Die dokter het dit gedoen, duidelik verbaas, en gesê: “Jou X-strale toon duidelik 'n ruggraatoperasie.”

Ek onthou my geboorteverhaal – my ruggraat getuig van werk wat sonder enige chirurgiese merke gedoen is. Ek dank Jesus dat Hy my ma se gebed aangehoor het, en ek dank U, Abba Vader, Here Jesus en Heilige Gees, vir al die wonderwerke wat U gedoen het en vir altyd sal doen.

## **Anoniem**



# *Generaal* **JORGE DA CRONHA VUNGULIPI**

Op 15 was hy 'n skerpskutter en 'n genadelose moordenaar wat Christene vervolg en doodgemaak het.

Die mees radikale en dramatiese optrede was toe hy 'n evangeliese pastoor tereggestel het. Kort voor sy teregstelling het hierdie pastoor vir generaal Vungulipi gevra of hy vir hom kon bid. Nadat hy gebid het, het hy vir generaal Vungulipi 'n Bybel van Die Gideons gegee en hom gevra om Romeine 10:20 te lees. Generaal Vungulipe het die gedeelte gelees, maar dit het nie vir hom sin gemaak nie. Hy het voorts die pastoor tereggestel.

Generaal Vungulipi was baie ontsteld toe hy nagedink het oor die pastoor se gebed, net voor hy hom tereggestel het. Hy het gebid: "Vader, vergewe hierdie jong man, want hy weet nie wat hy doen nie." Na daardie nag het die generaal 'n vrees ontwikkel en vir baie jare die klein Bybeltjie met hom saamgedra.

Toe word hy baie siek en het die Here Jesus Christus in 'n kerk aangeneem as persoonlike Verlosser en Saligmaker. Die predikant van die gemeente het hom gehelp om sy naam agter in die Gideontestament te skryf.

Gedurende 2011 het hy en sy vrou by die bediening van Die Gideons aangesluit en was hy 'n Gideon tot die dag van sy dood in 2014. As Gideon en uitvoerende direkteur van Die Gideons in Angola, het hy sy geloof beoefen deur Testamente aan sy kollegas en die soldate in die Weermag te gee. Hy het hulle gehelp om Jesus Christus as hul Here en Verlosser aan te neem – 'n nalatenskap van generaal Vungulipi.

**Christo Fourie**  
Harrismithtak

# *Wees bereid om te dien en* **BESKIKBAAR TE WEES**

Ek het 'n PWT aan 'n karwag by 'n supermark in Bethlehem oorhandig nadat my man, Chris, oorlede is. As weduwee was dit vir my nogal moeilik om vergaderings by te woon, want ek het hom te veel gemis, veral wanneer ek sien hoe gelukkig die ander paartjies is. Ek het getwyfel of ek moet aanhou om deel te wees van Die Gideons sonder my man.

Ek het die Here gevra om vir my te wys wat om te doen en toe gewag vir Sy antwoord. Na 'n rukkie is ek na dieselfde supermark. Ek het 'n stem gehoor roep en toe ek omdraai, hardloop die karwag na my toe en waai met iets in sy hand. Toe hy by my kom, het hy opgewonde vir my gesê: “Mevrou, dit was jy, dit was jy wat vir my hierdie Bybel gegee het en nou ken ek Jesus.”

Die Here het my gebede verhoor, het ek opgewonde gedink. Ek het selfs vergeet wat ek wou koop, in my motor geklim en die Here gedank vir Sy getrouheid. Die Here het hierdie man met sy PWT gebruik om vir my te wys dat ek moet voortgaan in hierdie bediening.

En nou, byna sestien jaar later, kan God steeds 'n beskeie weduwee in Sy diens gebruik. Hy kan enigiemand gebruik – wees net bereid en beskikbaar om Hom te dien. Ek loof en prys Hom vir Sy genade.

**Sarieta Wentzel**  
Oranjetak

# 'n Pragtige

## BOEK

Ek het gister die dokter, 'n nie-gelowige, besoek vir my na-operasiekonsultasie. Prys die Here, alles gaan goed en ek genees mooi.

Terwyl ek wag in die spreekkamer, het ek 'n tweetalige Bybel, geplaas deur Die Gideons, opgetel en begin lees. Ek het by myself geglimlag, wetende dat 'n mede-Gideon hier was om die goeie Woord te versprei.

“Pragtige boek, is dit nie,” sê 'n dame aan die oorkant van die tafel. Die Bybel het 'n gesprek oor Christus begin. Ek glo werklik dat die ander mense in die wagkamer wel die Woord in een of ander vorm gehoor het.

'n Besondere oomblik en atmosfeer is geskep deur net 'n Bybel, geplaas deur Die Gideons, op te tel.

Dankie Here, vir Die Gideons wat voor my aankoms by die spreekkamer diensbaar was.

**Kuben Moodley**  
Randburgtak

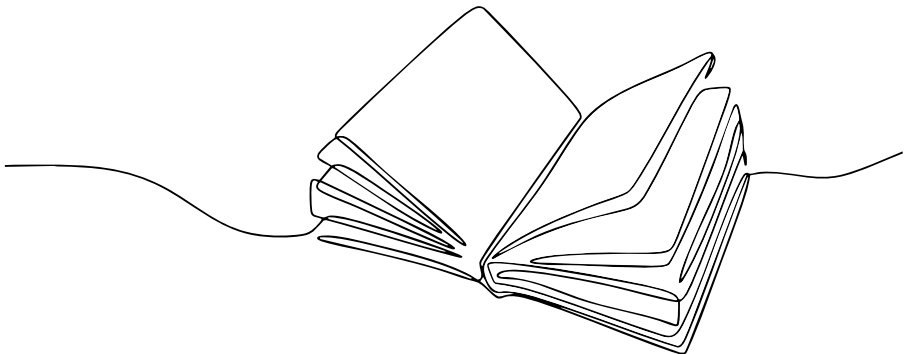

# *Geseënde*

## **PLASING**

Die graad 8-leerlinge se hoofonderwyser het my vergesel en aan die 30 leerlinge voorgestel, waarna die Bybels uitgedeel was. Ek het verduidelik wie ek was en watter waarde die Bybels tot hulle lewens sal toevoeg. Die leerlinge het aangehoor dat die impak van die Woord eers 'n werklikheid sal word wanneer hulle dit lees. God se verlossingsplan is met hulle gedeel, ek het vir hulle gebid en gevra hulle moet onderneem om elke dag die Woord te lees.

Die onderwyser het versoek dat ek dieselfde boodskap vir die “probleem klas” moet bring. Ek het dadelik aangevoel dat hierdie studente “anders” was. Tot my verbasing het hulle dadelik stil geraak en geluister toe ek met my praatjie begin. Ek het dieselfde reaksie met beide klasse ondervind, al was die een klas 'n “probleem” klas.

Die skoolhoof en die graad 8-hoofonderwyser het my bedank en nog sewe Testamente versoek vir die graad 12-leerlinge wat nie 'n Bybel het nie. Hy het ook gevra of ek kan help as hy geestelike hulp by die skool benodig. Ek het myself daartoe verbind om vir hulle beskikbaar te wees wanneer nodig.

Ons bid dat hierdie 60 lewens vir ewig verander sal word deur die Woord van God, wat nooit leeg na Hom sal terugkeer nie.

Aan God al die eer.

**Peet Van Der Merwe**  
Randburgtak

# *Die ou dinge het*

## **VERBYGEGAAN**

“My naam is Cheslin Janse. Ek is oorspronklik van George. Ek het by pleegouers gebly omdat my biologiese ma te jonk was om vir my te sorg. My pleegouers het my aanvaar as hulle eie en het ek hulle pa en ma genoem. Ek het elke dag na die New Dawn Park Laerskool toe geloop.

My peetpa het ’n drankprobleem gehad en daarom het my peetma ons verlaat. Later het my peetpa vir hom ’n jong meisie gekry. Sy het vir ons kos gemaak en na my gekyk wanneer my peetpa gewerk het. Sy is toe ook later weg.

Een aand het my pa kos gemaak en ons het dit saam geniet. Ek het my slaapklere aangetrek want ek het daarvan gehou om by sy voetenent te slaap. Die volgende oggend word ek wakker en vind uit my pa het selfmoord gepleeg.

My lewe was nie weer dieselfde nie. Ek moes by my biologiese ma en stiefpa gaan bly. Ek het nog steeds elke dag na dieselfde skool geloop. Die een persoon vir wie ek so baie lief was, is skielik weg. Nie dat ek nie vir my eie ma lief was nie, maar ek het net aan myself gedink, aan die pyn wat ek het.

Ek het skool bygewoon net tot Graad 5 en toe begin dagga rook, pille en tik misbruik. Op die ouderdom van 17 het ek betrokke geraak by bendes, begin steel en lieg, en later skoolkinders beroof. Hierdie was keuses wat ek gemaak het as gevolg van die pyn in my lewe.

Ek was al ’n paar keer in die verbeteringskool gewees, maar ek het net meer misdade gepleeg soos trokkapings, mensehandel en huisroof. Toe word ek gevang en agt jaar tronk toe gestuur. Ek was deel van ’n bende in kamer drie in die tronk en het sodoende as bendelid outoriteit gehad. Ek het vir maande nie geslaap nie, uit vrees dat een my gaan vermoor.

Ons word toe geskuif na kamer een, waar oom Gellie my kom roep het vir 'n afspraak met oom Johan Boshoff en op daardie dag het iets wonderlik gebeur: 'n gevoel in my binneste wat ek nie kan beskryf nie, maar vandag kan ek met 'n oop hart sê dit was die Here my God gewees wat met my gepraat het.

Vandag lewe ek soos 'n nuwe mens alhoewel ek steeds in die tronk is, want die kettings van die sonde is gebreek. Sê dankie vir die Here en ook vir oom Johan, wat die Here kon gebruik.

Die Here sê in 2 Korintiërs 5:17 (AFR 2020):

**‘Daarom, as iemand in Christus is, is hy ’n nuwe skepping. Die ou dinge het verbygegaan – kyk, hulle het nuut geword.’**

Die wonderlikste is dat my familie weer in kontak is met my. Die Here wil vir jou gee wat die wêreld nie vir jou kan gee nie, en dit is die Ewige Lewe wat die Here vir elkeen kan gee as jy Hom aanneem. Dit is my getuienis.”

**Johan Boshoff**  
Mosselbaaitak

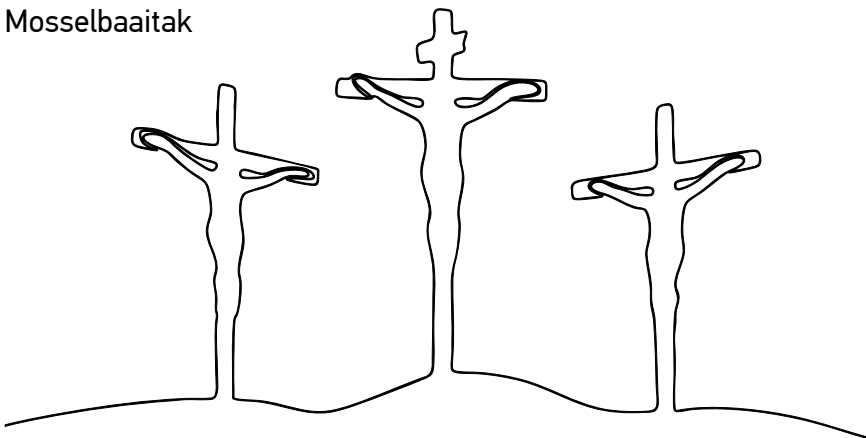

*Getuienis:*

# DA GAMA POLISIESELLE

Deur die genade van die Here het 'n polisiekolonel Die Gideons toestemming gegee om Sondagmiddae tussen 14:00 en 16:00 die polisie-selle by Da Gama-polisiestasie te besoek.

Ek was deel van 'n groep van agt mense. Daar was ook twee Gideonsvroue teenwoordig wat Bybels aan die vroulike gevangenes oorhandig het.

Ek het met ongeveer 23 buitelandse gevangenes in een sel gepraat. Ek het die hele weg van saligheid aan hulle verduidelik en aan elkeen 'n eksemplaar van die Nuwe Testament uitgedeel.

Dit was wonderlik om die volgende Sondag weer daardie sel te besoek. Al 23 gevangenes was nog steeds daar.

Aangesien hul reeds die Goeie Nuus ontvang het, kon ek net daarop uitbrei en het hulle uitgedaag om 'n besluit vir Christus te neem. Baie van hulle het gesê hulle het die Testament gedurende daardie week gelees, so die Heilige Gees was reeds aan die werk. Ek het hulle toe genooi om saam met my te bid om Christus te ontvang en hul lewens aan Hom oor te gee, wat hulle almal gedoen het.

Wat 'n magtige God dien ons tog nie! Aan God kom al die eer toe.

**Oscar Ehrensperger**  
Mosselbaaitak

# *Bemagtig ander mense*

## **OM SIELE TE WEN**

Ek deel graag 'n getuienis van toe my man in die hospitaal opgeneem is en die dame by die ontvangs baie moeite gedoen het. Ek wou haar 'n koppie koffie aanbied uit dankbaarheid maar sy het dit van die hand gewys. Ek het toe vir haar 'n Bybel gegee, waaroor sy baie verbaas was. Ons vergeet baie keer om nie net 'n siel vir Jesus te wen nie, maar om vir ander 'n instrument te gee waarmee hulle kan werk. Sy sien daagliks vele pasiënte wanneer hulle opgeneem word.

Ek verduidelik toe vir haar dat sy voor in die Bybel kan sien waarvoor sy moet bid en waar sy die nodige versies vir sekere omstandighede kan kry om mense te bemoedig. Ek het voorgestel dat sy sekere versies kan neerskryf vir die pasiënt wat bemoediging nodig het. Sy was verstom dat sy ook 'n doel het om siele vir Jesus te wen op daardie manier. Sy het belowe om die Bybel op haar lessenaar te hou.

Hierdie was vir 'n ander manier om met ons Gideons se PWT'e siele vir Jesus te wen. Dit is om ander by te staan wat 'n groot passie vir Jesus en mense het, en so 'n blywende verskil in mense se lewens maak.

**Sonna Kitching**  
Queenstowntak

# *Die werk van die* **HEILIGE GEES**

My vrou, Diana, het 'n Bybelpasing gedoen by 'n tehuis vir pasiënte wat ly aan Alzheimer en Dementia. Na die pasing het die suster in beheer vir haar gevra of sy nie iemand ken wat hierdie mense periodiek geestelik kon bedien nie. Die “kerk” het aangedui dat hulle nie kan nie en Diana het my toe genomineer vir hierdie taak. Ek het hulle gaan sien en het ingestem om hulle Woensdagmiddae te besoek.

Ek onthou hoe ek tydens daardie eerste besoek langs die pad stilgehou het om te bid en die Here vir wysheid gevra het, omdat ek so onbevoeg gevoel het. Die Here het in my gees met my gepraat en gesê ek moet met die gees van die mense praat. Ek vra toe die Heilige Gees om kommunikasie met hulle gees moontlik te maak. Ek het sorgvuldig opgelet na hulle reaksie en kon waarneem dat daar beslis 'n positiewe reaksie in hulle gees was.

Die suster het genoem dat daar merkwaardige reaksies was. Sy sê dat “iets” net anders was en gevra dat ek moet voortgaan met die bediening. Ek het aan haar verduidelik wat ek gebid het en dat God besig is om iets groots te doen en my te leer om betekenisvol in hierdie veld te kommunikeer.

God het hierdie pasiënte net so lief soos Hy die res van die wêreld het. Hy het sy Seun gegee om Sy lewe ook vir hulle af te lê. Ek moedig hierdie kosbare mense aan deur hulle te vertel dat hulle die wêreld daar buite kan verander deur gebed. Hulle kan steeds toetree tot geestelike oorlogvoering. Aan Hom al die eer!

**Peet Van Der Merwe**  
Randburgtak

*In tye*

# VAN NOOD

**“In my nood het ek na die Here geroep, die Here het my gebed verhoor en my bevry” (Psalm 118:5 AFR83).**

Die takleier van Harrismith, Cobus de Jager en sy gesin, was in April 2020 gediagnoseer met die Corona virus. Terwyl hy uiters kritiek in die hospitaal gelê het, het verskeie Gideons en Gideonsvroue getrou vir hom gebid. Cobus en Mary se getuienis is dat hulle werklik vir die eerste keer besef het hoe geseënd dit is om deel van hierdie bediening te kan wees. Hy sê hulle het oproepe en SMS'e ontvang van Gideons van regoor die hele land. Hy het nooit besef hoe vinnig en kragtig die gebedsbediening van Die Gideons is nie. Dit het vir hulle as familie ontsettend baie beteken in 'n tyd van groot krisis. Die vers wat hom die hele tyd bybly:

**“Moenie die dag van klein dingetjies gering ag nie”  
(Sagaria 4:10a AFR83).**

Hy sal nooit weer dieselfde kyk na die bediening van Die Gideons of die takvergaderings nie. Die waarde van die tak se samesyn, inspirasie en beplanning sal hy nooit weer as vanselfsprekend aanvaar en gering ag nie.

Dankie vir elkeen wat getrou vir hom, Mary en hulle kinders gebid het. Hulle is deur diepe stormwaters – Mary het intussen haar pa as gevolg van die virus verloor. Sy kon nie op sy roudiens wees nie omdat sy self nog siek was op daardie stadium en hy in die Kaap gewoon het. Cobus was nog vir geruime tyd op suurstof, maar ons loof die Here vir volkome genesing van die gesin.

**Koers Fourie**  
Harrismithtak

# Getrou

## IN TURKYE

Hierdie getuienis is verskaf deur Esmari en Paul, sendelinge woonagtig in Somerset-Wes. Hulle het in 2005 'n gebedstoer onderneem na Turkye.

In die hotel by Kusadasi ontmoet hulle 'n dame genaamd Malech, wat 'engel' beteken, en sy deel haar getuienis met hulle.

Haar pa was op 'n sakereis na Istanboel en het by die hotel al die gratis items soos seep, sjampoe, koffie en 'n boek ingepak. Later, toe hy alles by die huis begin uitpak, het hy besef dat die boek wat hy geneem het 'n Bybel is – en toe het hy dit in die vullismandjie gegooi.

Sonder sy wete het sy vrou die Bybel uit die vullismandjie gehaal en dit begin lees. Sy het Jesus Christus deur die Woord aangeneem as haar persoonlike Verlosser. Hierdie goeie nuus het sy aan haar man oorgedra en hy het gedink sy is gek en geweier dat sy in dieselfde kamer slaap. Hy laat egter sy dogter Malech toe om by hom in te trek.

Een nag het hulle wakker geword met 'n lig wat in hulle kamer skyn. Terwyl hulle redeneer oor die lig, verskyn 'n engel aan hulle en sê: "Moenie bang wees nie. Ek is 'n engel gestuur deur God. Jou vrou is nie mal soos jy dink nie. Sy het die Here Jesus Christus gevind en jy moet luister na wat sy sê."

Na die verskynsel het Malech en haar pa tot bekering gekom. Die hele dorpie het Jesus Christus as hulle persoonlike Verlosser aanvaar na hierdie voorval.

Dit alles omdat een Gideon getrou was om 'n Bybel in 'n hotelkamer te plaas.

*Getuienis van*

# **AJ WOHLFAHRT 2023**

Op 5 Februarie 2023 het ek en Barnie de Clerk, 'n mede-Gideon, die voorreg gehad om by die Krugersdorp tronkselle Testamente te plaas.

In die laaste sel noem ek dat ons vir hulle Goeie Nuus het en die Goeie Nuus is in die Testament. Ek daag hulle toe uit om die laaste bladsy te lees en 'n ewige besluit te neem.

Een gevangene stap nader en sê hy het die Testament die vorige dag gevind in hulle sel en het intussen sy hart vir die Here gegee. Isaac het gesê dat hy nou 'n wedergebore Christen is. Hy verruil sy Testament toe vir 'n nuwe een sodat ek sy getuienis met almal kan deel waar ons kom.

Moenie die krag van 'n Testament onderskat nie: dit word vir iemand gegee wat dalk net die instrument is om die boodskap by iemand anders uit te kry.

**A.J. Wohlfahrt**  
Krugersdorptak

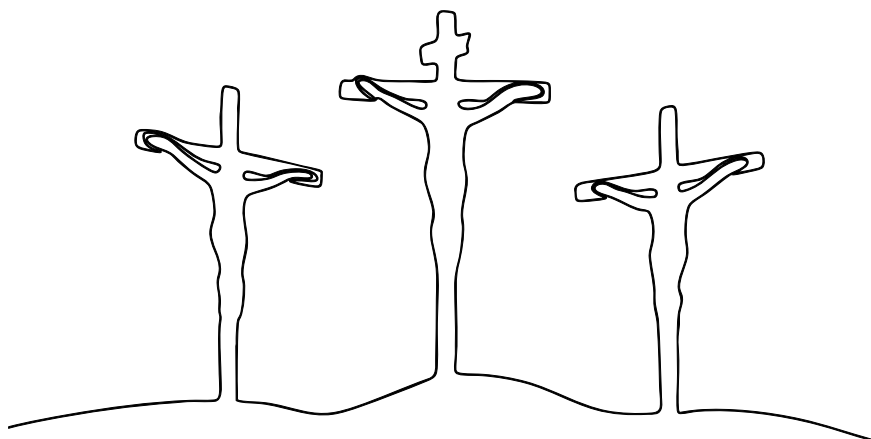

*Gedra*

## **DEUR GEBED**

Ek wil graag iets deel uit my persoonlike ervaring tydens die Covid-pandemie in die winter van 2020/21, spesifiek oor gebed en hoe dit ons dra in moeilike tye.

Ek het siek geword en was positief vir Covid getoets. Toe my suurstofvlakke begin daal het, is ek hospitaal toe. Ná 'n week in die Medikliniek in Thabazimbi waar my longe al hoe swakker begin funksioneer het, is ek met 'n helikopter na Welkom gevlieg, die enigste plek met 'n beskikbare ICU-bed en ventilator.

Ek is gesedeer voor die vlug en kon niks daarvan onthou nie. Vir 'n volle week is ek aan 'n ventilator gehou. Die dokter het vir my vrou Ané gesê my kans om te oorleef was een uit drie. Die statistieke daardie tyd in die ICU was baie sleg.

Mense het begin bid vir my en my gesin – ons het dit gevoel. Ek het nooit paniek of benoudheid ervaar nie, en Ané en die kinders het ook vrede beleef ondanks hulle eie uitdagings. Ons het regtig gevoel dat God ons dra en dat gelowiges ons ernstig opdra in gebed aan die Here.

Terwyl ek onder sedasie was, het ek 'n droom gehad: Ek en Ané het in Thabazimbi se winkelsentrum geloop. Ek het 'n suurstofmasker gedra en toe sy vinnig in 'n ander winkel ingaan, het my suurstof opgeraak. Ek het op die grond neergeval en geweet: dis my einde. Ek het probeer roep, maar sy kon my nie hoor nie want ek was bewusteloos. Toe eindig die droom.

Nadat ek uit die hospitaal ontslaan is en begin herstel het, het Ané my vertel dat sy een aand 'n dringende gevoel gehad het om vir my te bid – spesifiek om haar hande in die gees op my bors te lê. Dit was vir haar vreemd want ons is NG lidmate, maar sy het gehoorsaam gebid.

Later hoor ons van 'n vriend in Harrismith wat dieselfde beleef het: 'n aand se dringendheid om vir my te bid en in die gees hande op my te lê.

Hy het selfs gevoel hoe sy hande warm geword het. En nóg later hoor ons van 'n familielid in die Kaap wat op dieselfde tyd dieselfde ervaring gehad het.

Ek glo dit was die oomblik in my droom toe ek in die gees uitgeroep het en die Here het mense gelei om vir my te bid.

Gebed maak 'n verskil. Wanneer die Gees jou lei om te bid, luister. Moenie uitstel of twyfel nie. Bid sonder ophou.

**Diederik Esterhuizen**  
Thabazimbitak

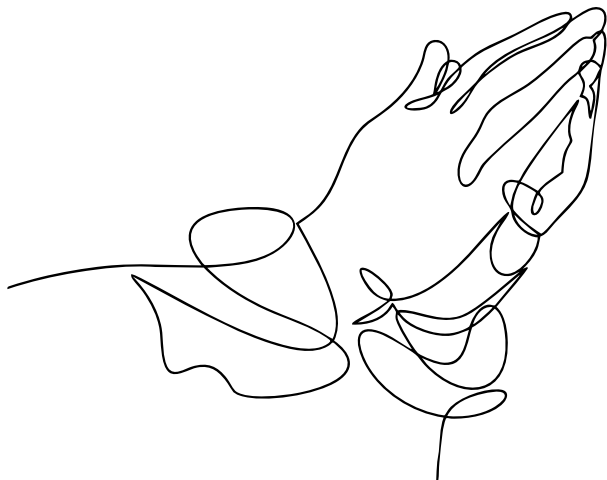

*God is*

# GENADIG

Ek het baie oomblikke van genade beleef gedurende die Durban Kwa-Zulu Natal ISB 2025. Ek glo hierdie is klein treetjies tot die redding van baie.

Met my aankoms by Johannesburg-lughawe, het 'n Venda-portier my na die binnelandse vlugtoonbank vergesel. Ek het reeds al my klein Testamente uitgedeel en haal toe 'n gebruikte Bybel uit my tas. Ek bid saam met Sachimo dat hy 'n openbaring van Jesus sal ontvang, omdat hy verklaar het dat hy Jesus liefhet.

Ons dae het vroeg begin met 'n biduur, vinnige ontbyt en dan vertrek na skole. Baie skole is besoek en Testamente was uitgedeel. Dit was 'n groot seën om die nood vir die Woord te ervaar en die getrouheid van die Here te beleef. My ervarings sal vir lank by my bly.

Ek het die voorreg gehad om 18 Persoonlikewerkerstestamente in die area waar ons tuis gegaan het, uit te deel. 'n Jong man met die naam van Rasheem het die Sondag 'n kerkaanbieding deur 'n Gideon bygewoon. Dit het sy hart aangeraak en hy wou graag 'n Testament ontvang.

God se genade is groot in Sy goedheid en getrouheid. Aan God al die eer.

**James Milson**

Australiese ISB-lid

*Gered van*

# **SELFMOORD**

'n Hartroerende ketting van gebeure wat die ongelooflike impak van 'n *Vriende*-Testament demonstreer, het alles begin toe 'n ouma van ons kerk haar begeerte uitgespreek het vir een van die Bybeltjies wat tydens die Sondagskool aan die kinders uitgedeel was. Ek belowe om vir haar 'n Afrikaanse Bybeltjie te reël. Haar skoonseun besoek ons winkel en ek vra hom om skoonma se Bybeltjie saam te vat. Die jongman noem dat die Bybeltjie bedoel is vir sy jongste kind wat nie 'n Bybel gekry het nie.

Hierdie getuienis begin deur 'n boks Bybeltjies wat aangestuur is na 'n *Vriend van Gideons*, wie 'n behoefte raakgesien het om Bybeltjies vir kinders te gee. Die kinders besoek gewoonlik 'n ander kerk, maar daardie Sondag het die oudste kleinseun saam met sy ouma kerk toe gekom.

Die Here het dit bewerk dat die Bybeltjies op daardie Sondag uitgedeel word. Die seun was so opgewonde oor sy Bybeltjie en het dit elke dag saam met hom gedra in sy skoolsak.

Een van sy maatjies het hom vertel dat hy nie meer wil lewe nie, dat hy gaan selfmoord pleeg. Die seun pluk toe dadelik sy Bybeltjie uit sy sak en onthou waar hy moet kyk as hy 'n krisis het. Hy soek toe 'n paar versies op en lees dit vir sy vriend. Die versies het iets gedoen vir sy vriend wat daarna besluit het om nie voort te gaan met die selfmoordpoging nie.

Die pad van daardie Testament het nie daar geëindig nie – dit het 'n diep indruk gemaak toe die Bybelversies betekenis gekry het vir sy maatjie. Ons prys die Here daarvoor. Ons ken nie die weg van 'n Bybeltjie nie, maar God weet wie het dit nodig.

Met dankbaarheid.

**Van 'n Gideon**

*God is*

# **GETROU**

In die parkeerarea buite ons Pick & Pay-sentrum hier in George ontmoet ek 'n jong motorwag met die naam Bradley. Hy is ongeveer 35 jaar oud, baie netjies en boonop Engelssprekend.

Ek het 'n R10 noot gehad om vir hom te gee, maar ek nooi hom toe tot by my bakkie en vertel hom dat ek hom baie meer as die R10 kan aanbied as hy wil luister. So bedien ek hom toe met 'n Engelse PWT en verduidelik aan hom die aanwysings en die pad na saligheid. Ek ry die volgende dag weer by hom aan en doen toe weer 'n gebed vir hom.

Twee weke later is ek by 'n groothandelaar wat boutoerusting verkoop. Hier pyl 'n man op my af in konstruksiewerkerklere. Ek het hom glad nie herken nie – dit was Bradley! Opgewonde vertel hy my dat Jesus sy hele lewe verander het vandat hy die Bybel ontvang het en sy saak met God reggemaak het. 'n Bouer het in dieselfde parkeerarea vir hom 'n goeie werk as voorman op 'n bouperseel aangebied teen goeie betaling.

Alle eer aan God vir Sy groot trou.

**Johan Bruwer**  
Georgetak

*Van motorwag*

# TOT KERKPLANTER

Pastoor John het ons gekontak uit Tanzanië waar hy tans werk onder verlore mense, plaaslik en in die Demokratiese Republiek van die Kongo. Hy het met Gideons uit Australië, wie daar op safari was, kontak gemaak en tyd met hulle gespandeer.

Die besoekende Gideons het van sy dienste bygewoon en hom geseën met fondse. Hy bly Die Gideons verhef as die bediening wat hom na Jesus gelei het, en herinner elke gelowige daaraan om die Here te dank vir die bediening van Die Gideons aangesien hulle almal indirek baat by die werk wat Die Gideons doen.

Sy getal gemeentede groei daaglik. Pastoor John was 'n motorwag by Checkers Hyperama waar hy sy hart aan die Here gegee het nadat hy 'n PWT van 'n Gideonsvrou ontvang het. Sedertdien het hy Suid-Afrika verlaat om onder die verlore nes in Afrika te werk en is op pad na Burundi om sy werk daar voort te sit.

Aan God al die eer!

**Corné en Anita de Jager**  
Bethlehemtak

*Baie meer*

## **AS NET KOS**

Na 'n suksesvolle hospitaalplasing in Bethlehem op 14 April 2017 het ons in 'n parkeerarea gestop om wegneemetes te koop vir middagete. Terwyl my man Corné nog besig was in die winkel, het 'n dame my genader om vir haar kos te koop. Ek het egter gevoel dat ek eerder vir haar geld wil gee; dan kan sy self kos koop en moontlik geld oorhou vir ander benodighede. Ek het 'n Persoonlikewerkerstestament uitgehaal om saam met die geld vir haar te gee.

Toe sy die Testament sien het haar oë dadelik vol trane geskiet. Sy het my gevra of ek haar kan help om haar hart vir die Here te gee.

Dit was vir my 'n groot voorreg om daar in die parkeerarea die weg van saligheid aan haar te verduidelik en het ook die gedeeltes voor in die Testament aan haar gewys. Sy het 'n oorgawe gemaak – ek kon haar in gebed lei om haar lewe met die Here reg te maak. Dit is my gebed dat sy dit opreg bedoel het toe sy die keuse gemaak het. Ek het aan haar verduidelik dat om die Here as Verlosser aan te neem, nie 'n waarborg is dat ons probleme almal sal weggaan nie, maar dat Hy nou daar is om haar deur moeilike tye te help. Ek het ook aan haar verduidelik dat Hy sal voorsien, dalk nie soos sy wil of wanneer sy wil nie, maar op God se tyd en manier.

En so kry Lindsey toe baie meer as net kos.

Aan God al die eer.

**Anita de Jager**  
Bethlehemtak

*God gebruik ons*

## **WAAR ONS IS**

Ek is 'n fisioterapeut en het 'n jong meisie met baie pyn behandel.

Soos die gesprek gevorder het, deel ek met haar my geloofsperspektief. Sy is daar weg met die belofte dat sy weer sou kom vir behandeling. Tot my verbasing het sy wel 'n afspraak gemaak en gekom.

Deur die loop van die behandeling het ek met haar die weg van saligheid gedeel. Sy besluit toe net daar sy wil haar lewe vir die Here gee – sonder dat ek haar eers gevra het! Gou het ek haar net daar op die bed gelos en 'n pienk PWT in die kar gaan kry en saam met haar gebid.

Prys die Here!

**Leana Mostert**

Capricorn-Noordtak

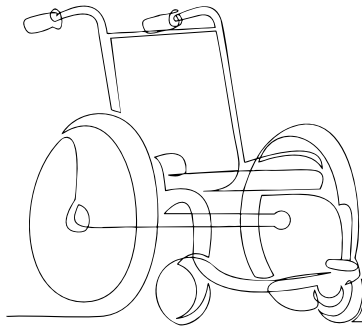

*Goeie nuus*

# AFGELEWER

'n Pastoor, wat gevra het om anoniem te bly, is 'n *Vriend van Gideons*.

In hierdie hoedanigheid ontvang hy elke drie maande drie Nuwe Testamente per koerier. Toe die Testamente in Julie afgelewer is, het die Gees hom aangespoor om die bestuurder van die koeriermaatskappy te vra of hy 'n Bybel wil hê. Die gevolg was dat 'n nuwe siel na Christus gelei is en sy het die sondaarsgebed saam met die pastoor gebid.

Die engele juig oor 'n sondaar wat 'n nuwe mens in Christus geword het.

Alle eer aan die Here!

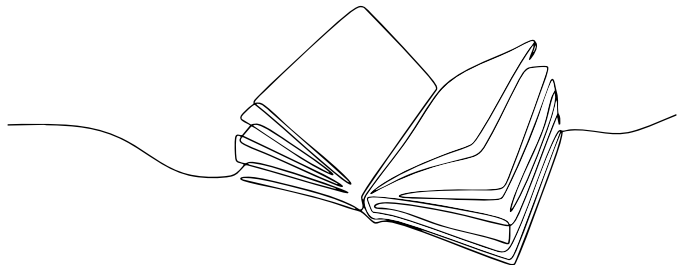

*Hier is ek Here,*

## **GEBRUIK MY!**

Om op die Butterworthplasing saam met my vrou en ander hartsvriende wat lief is vir ons Vader, die Testamente vir verloregeande siele te gaan saai, was 'n besondere voorreg om te beleef. Ons was by al die skole met ope arms ontvang en ons span kon oor die 3 400 Testamente in die twee dae uitdeel.

Meeste plekke moes ons slegte paaie ry om by skole te kom waar die klasse geen gekleurde plakkate op het nie, net kaal mure en party selfs stukkende skoolbanke waar glimlaggende kinders drie-drie op tweesitplekbanke sit. Almal was gretig met oop hande en harte vir sy eie Testamentjie.

Die seën wat ons saam hiermee ervaar het, is vervolmaak met die pragtige natuur wat ons God geskep het. Dis plekke waar ons nooit sou uitkom as dit nie vir die wonderlike bediening van Die Gideons was nie. Dit is waarlik 'n groot voorreg om in hierdie bediening te kan dien!

Mag God verheerlik word en Sy koninkryk uitbrei met elke Testamentjie wat uitgedeel is tydens die blitze.

My gebed wat ek sal wil hê almal moet bid, is: “Hier is ek Here, gebruik my! Amen.”

**Robert en Louise York**

Ghaaptak

# Getuienis

## ISB 2025

Ek is KZN toe vir my eerste Bybelblitz. Maandag, die eerste dag, was wonderlik.

Die eerste skool was die grootste van almal. Daar was 1 700 studente en hulle het hul skoolhoof verras vir sy verjaardag. Ons het ook 'n skool in Richmond besoek, die Pietermaritzburg Plattelandskool. Die skoolhoof is nuut en is 'n pastoor. Sedert hy by die skool begin het, handhaaf hulle 'n 100% slaagsyfer. Die ander skool, 'n Moslemskool, het ons ná 'n gesukkel toegelaat. Hulle het 'n groep Christene met wie ons die Woord gedeel het. Hulle was baie dankbaar.

Ek het geleer hoe om voor te berei vir toekomstige blitze. Ek het ook nuwe mense in Die Gideons ontmoet. Ek het beslis verbeter in my benadering tot multikulturele skole met verskeie tale. Om mense met 'n diverse kulturele agtergrond te ontmoet is 'n uitdaging. Maar by God is alle dinge moontlik.

**Patience Makiwa**

Johannesburg-Suidtak

# LAASTE PWT

In Junie 2017 het 'ngesin vandrie op 'n tweewekelange vakansie na Namibië vertrek. In hul bagasie was verskeie Persoonlikewerkerstestamente. Terwyl hulle gereis het, het hulle die Testamente entoesiasties en met groot sukses gedeel. Gou het hulle besef hulle het te min Testamente gepak vir die geleentheid wat oor hul pad gekom het.

Met net een Engelse Persoonlikewerkerstestament oor, het die gesin die Namibwoestyn aangedurf – 'n ervaring wat hul hoogtepunt van die reis sou wees. Terwyl hulle op en af oor die duine gery het, het die adrenalien gevloei en hulle nog nader aan mekaar gebring. Hierdie avontuur het hul empatie en bewondering vir die Israëliete verdiep, wat 40 jaar deur die woestyn getrek het – 'n prestasie wat hulle nou beter verstaan het.

Na drie ure in die woestyn het hulle weer hul basis bereik. Die gids wat die gesin vergesel het, het nog nooit 'n Bybel gehad nie. Die laaste Engelse Persoonlikewerkerstestament kon hulle met hom deel. Die gesin se bereidwilligheid om uitdagings te trotseer het beteken dat die gids ook sy eie Bybel kon ontvang.

Mag ons nooit moeg word om siele vir Jesus te wen nie.

**Gidoensegpaar**

# Moedersdag

## 2022

Ons het 'n onderwyser in Vryburg wat wonderlike werk doen onder die arm gemeenskap daar. Dit is vir hom 'n passie om 'n verskil in hierdie kinders se lewens te maak.

Hy het nou begin om saam met hulle Bybel te lees en te bid. Uit hierdie groepie kinders het hy al soveel talent ontgin. As gevolg van die onderwyser se toewyding het een van die leerders vanjaar beide 'n silwer- en bronsmedalje by die Suid-Afrikaanse skole-atletiekkompetisie gewen.

Ek het die voorreg gehad om saam met hom PWT'e as Moedersdag geskenke aan hierdie gesinne te oorhandig, met die versoek: lees dit saam met julle kinders.

Die kinders was so opgewonde om 'n geskenkie vir hulle ouers te kon gee. Hulle het nog nooit die voorreg gehad om vir mamma of ouma, in die meeste se geval, op Moedersdag iets te kon gee nie. Bid saam met my dat hierdie Testamente regtig 'n verskil in hierdie gesinne se lewens sal maak.

Kom ons gaan uit en leef Jesus se liefde, want dit ken geen einde nie!

**Esta Putter**

Vryburgtak

*Loof God vir die*

## **ISB IN SUID-AFRIKA**

Ek prys God vir wat Hy in die Suid-Afrikaanse ISB gedoen het. Sy weë is soveel beter as ons s'n, en wat Hy doen, oortref alles wat ons ooit kan dink of voorstel! Ek dank God dat Hy ons die wonderlike dinge wat Hy doen en aanhou doen, wys. Die volgende verse kom by my op:

**“Aan Hom wat deur sy krag wat in ons werk, magtig is om oneindig meer te doen as wat ons bid of dink, aan Hom kom die eer toe in die kerk, deur Christus Jesus, in alle geslagte tot in alle ewigheid. Amen” (Efesiërs 3:20-21 AFR83).**

Ek loof God dat Hy 'n oorspronklike doelwit van 300 000 Testamente oortref het deur meer as 411 000 te laat plaas. Ek prys Hom ook vir die 495 geleenthede vir persoonlike bediening waarvan ons bewus is, en vir die 95 kerkaanbiedings wat gehou is.

Ek het baie begeestered en bemoedig huis toe gekom en ek dank God vir die uitslae van die ISB wat sal voortleef.

Mag elkeen van julle bemoedig wees en God dank vir Sy getrouheid om oop deure en oop harte te voorsien, alles tot Sy eer!

**John Mannen**

VSA ISB-lid

*Die Here*

## **VOORSIEN ALTYD...**

Uit vorige ervaring het ons geleer dat slegs Engels aanvaar word in die groot dorpe omdat leerders geen ander taal kan lees nie.

Groot was ons teleurstelling toe ons by die depot in Kokstad kom om Testamente te laai, en daar is slegs 'n paar Engelse en verder net Zulu Testamente. Ek en my vrou was egter positief en laai toe 4 000 Engelse Testamente om mee te begin. Maar na ons 2 grootste skole-besoeke Maandag, was ons Engelse voorraad op - intedeel was ons 2 Testamente kort.

Ons is terug depot toe om nog voorraad te laai, net om te ontdek daar is geen Engelse Testamente nie. So, met Zulu Testamente gelaai, besoek ons twee skole wat verwelkomend was, maar negatief reageer want hulle studente kan nie Zulu lees nie. Ons stuur 'n dringende boodskap op die WhatsApp groep uit vir hulp met Engelse Testamente.

Ons bedien nog twee skole en 'n kollege van 600 studente met die Zulu Testamente.

Aangesien ons nie meer werk gehad het nie, gaan help ons 'n ander span. Op pad ontvang ons 'n boodskap van die kollege om die Zulu Testamente te kom afhaal want die studente kan nie Zulu lees nie. Verpletter noem ons die situasie aan die span wat ons help, en was ons verras met hulle reaksie: "Ons het Engelse Testamente wat ons nou sou gaan teruggee." Ons ontmoet mekaar en ons ontvang die 1 100 Engelse Testamente!

Die Here het ingetree en die presiese getal voorsien wat ons benodig het om ons taak te voltooi. Eer aan die Here!

**Johann en Marguerite Minnaar**  
Mosselbaaitak

# *Die antwoord*

## **IS GEBED**

Ek kom vroeg een Dinsdagoggend by die skool om 'n afspraak te maak om Testamente uit te deel by die saalbyeenkoms vir die komende Donderdag. Die skoolhoof deel my mee dat daar 'n waterskaarste in die area is en dat hy al die leerders sal moet huistoe stuur. Hy meld ook dat so 'n probleem drie tot vier dae neem om reg te stel.

Ons is net vir die week in Durban vir die ISB blitz. Hoe sal ons hierdie Testamente kan plaas? Daardie middag bid ons saam met die Durban-Gideons. Na die gebedsessie sien ek 'n staatsamptenaar wat watermeterlesings in die pad neem. Ek vra hom toe oor die probleem, en hy sê dat een van die pompe moeilikheid gegee het, maar dat dit intussen op wonderbaarlike wyse herstel is en dat die watertoevoer in die area onmiddellik herstel is.

Ons Hemelse Vader het ons gebede beantwoord en kon ons agt skole besoek in die area en 3 500 Testamente in kinders se hande plaas.

Ons het gebid. God het geantwoord en deure oopgemaak, sodat Sy Woord gedeel kon word. Ons dien 'n wonderlike God... Hy maak die onmoontlike, MOONTLIK.

**Kuben Moodley**  
Randburgtak

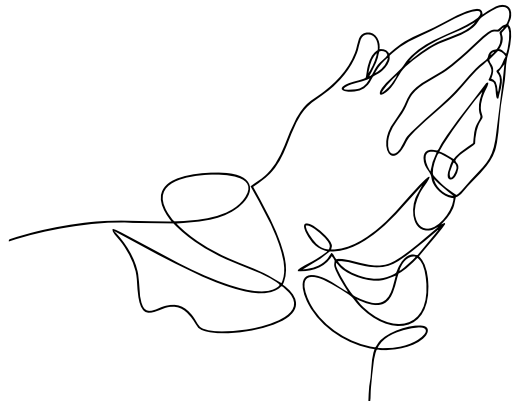

*'n Pienk fout...*

# OF 'N GODDELIKE AFSPRAAK?

Donderdag 8 Mei het Erik en Ansie Oosthuizen van die Hennopstak, die Bybelstoorplek besoek om Testamente te gaan haal vir plasings. Hulle het Engelse Testamente nodig gehad, maar toe hulle daar aankom, was daar niemand beskikbaar om hulle te help nie. Onverstoord het hulle self die kartondose opgelaai, die besonderhede neergeskryf en vertrek na hul plasingsbestemming.

Hulle bestemming: 'n Moslem-skool waar hulle, gebaseer op vorige ervarings, maar sowat 40% aanvaarding verwag het. Geen aanbiedings word daar toegelaat nie en vorige besoeke het dié beperkte geleentheid bevestig.

Maar toe hulle die kartondose oopmaak, het alles verander – dit was vol pienk Testamente! Hulle het per ongeluk die verkeerde kartondose geneem. Daar was egter geen tyd vir omruil nie – hulle moes voortgaan.

En toe gebeur iets besonders...

Die oomblik toe die meisies die pienk Testamente sien, het opgewondenheid soos 'n veldbrand onder hulle versprei. Skielik het dit nie meer net oor godsdiens gegaan nie, maar eerder oor kleur! Al die meisies wou die oulike pienk Testamente hê. En die seuns? Hulle wou die bloues hê!

Een dapper seun het selfs na Erik toe gekom en gesê: “Ek wil ook 'n pienk een hê.” En natuurlik het Erik hom sonder twyfel een gegee.

Toe hulle later die totaal bereken, was hulle stomgeslaan: 80% van die leerders by daardie skool het 'n Nuwe Testament aanvaar.

Wat begin het as 'n eenvoudige fout, einding toe as 'n goddelike afspraak.  
Prys die Here! Mag hierdie Testamente hul pad vind na Moslem-huise,  
daar gelees word met oop harte en die lewens van baie mense aanraak.

### **ISB Umhlangaspan**



# *God se goedheid*

## **IN GHANA**

Ek het pas teruggekeer van Ghana waar ek vir 'n week en 'n half gewerk het. Ek het in 'n hotel gebly en opgemerk dat daar 'n tweetalige Testament in die kamer was. Wat my egter die meeste getref het, was 'n ontmoeting met 'n plaaslike inwoner wat, volgens hom, daardie oggend sterk gevoel het dat die Here hom na die hotel toe stuur – die plek waar ek toevallig tuisgegaan het.

Hy het vir sy vrou gesê hy het 'n innerlike oortuiging dat hy na daardie spesifieke hotel moes gaan. En dáár het hy my ontmoet. Hierdie man het 'n eenvoudige bakkery en 'n klein besigheid van die grond af opgebou. Een keer per week bring hy jongmense bymekaar, gee vir hulle gratis brood en verkondig dan die Woord deur vir hulle uit sy Bybel te lees.

Ek was gelukkig om 'n paar Engelse PWT'e saam te neem en kon vir hom vyf gee. Die man was oorweldig van vreugde en opregte dankbaarheid. Met trane in sy oë het hy verduidelik dat hy nou ses Testamente het waarmee hy onder die jongmense kon werk.

Vir my was dit 'n ware openbaring oor die betekenis van die werk wat ons doen. Dit het my weer laat besef: waar ons ook al gaan, die Here plaas ons doelbewus op plekke waar Hy ons kan gebruik. Ek het self gewonder hoekom ek spesifiek na Ghana gestuur is, buiten vir die landbouwerk wat ek moes doen. Hierdie ontmoeting het egter vir my alles duidelik gemaak.

Ek deel dit graag met julle, want dit is nog 'n bevestiging van die goedheid en leiding van die Here.

**Lieb Venter**

Tsitsikammatak

# *'n Jesus oomblik*

## **IN PORTUGAL**

Vandag het ek 'n ware Jesus oomblik beleef! Teen 'n steil opdraand het ons 'n baie ou tannie met 'n boggelrug sien rus by 'n straatkafée. Dit was duidelik dat die eenaar haar ken – miskien gee hy haar gereeld iets om te eet. 'n Jong man het uit die kafée gekom en 'n koelsak aan haar oorhandig. Sy het nog 'n plastieksak vol kruideniersware ook gedra en ek het aangebied om dit vir haar te dra.

Sy het egter geweier en iets gesê met 'n paar indrukwekkende Portugese woorde. Ek het toe eenvoudig haar arm gevat, by haar ingehaak en saam begin stap. Sy het gelag en hardop kommentaar gelewer! Wat sy so luidkeels uitgeroep het, weet ons nie, maar mense rondom ons het begin lag en grappenderwys opmerkings gemaak.

Ek het toe met oorgawe in Afrikaans vir haar gesê: “Kom oumatjie, jy kan dit maak – ons gaan tot bo!” En bo, by die kruin van die opdraande, het sy my innig bedank. Toe gee ek vir haar 'n Brood van die Lewe in haar eie taal. Aanvanklik was sy huiwerig om dit te aanvaar, maar toe sy sien dis 'n Testament, het haar gesig verhelder met ongeloof en dankbaarheid. Dit het ons diep geraak!

Wie sou nou ooit kon dink dat Jesus my kan gebruik in vreemde land met 'n vreemde taal om Sy naam te verheerlik!

Dankie vir my Portugese PWT'e!

**Awie Thomas**

Maskamtak

*Raak*

# LEWENS AAN

Op Sondag 13 April 2025 daag Gideons en Gideonsvroue van Krugersdorp- tak op by die Yusuf Dadoo hospitaal. Soos gewoonlik verdeel ons in groepe nadat ons gebed het en betree die hospitaal.

Ek en my man bly oor en besluit dat ons dan maar vandag saam die plasing sal waarneem. Ons beweeg van saal tot saal, deel die evangelie en gee Testamente aan die personeel.

Terwyl ons deur die sale stap, hoor ons iemand na ons roep. Ons draai om en sien 'n jong man. Hy vra ons of ons hom dalk kan help. Hy is in hierdie hospitaal opgeneem omdat hy selfmoord wil pleeg. Ten spyte van hulp wat hy hier ontvang, dink hy nog steeds daaraan om selfmoord te pleeg.

Cobus antwoord hom dat ons hom kan help om Jesus aan te neem, want Jesus kan hom verseker help. In Johannes 10:10 (AFR83) staan daar:

**“Die dief kom net om te steel en uit te roei: Ek het gekom sodat hulle die lewe kan hê, en dit in oorvloed.”**

Ek verduidelik aan die jong man dat daar iemand is wat sy geluk, sy doel in die lewe en selfs sy lewe wil steel, maar Jesus wil aan hom lewe gee en dit in oorvloed. Vir Jesus is hy baie belangrik, want Hy het 'n doel met die jongman se lewe.

Saam kon Cobus en ek die evangelie met hierdie jongman deel.

Die jongman vra ons toe of ons hom kan help om Jesus aan te neem. Cobus het aan hom verduidelik dat hy sal bid en dan kan die jongman dit

herhaal wat hy bid. Saam het hulle die verlossingsgebed gebid.

Dit was so mooi toe hulle amen sê en ons vir die eerste keer lewe in die jongman se oë kon sien en 'n glimlag op sy gesig.

Wat 'n voorreg om deur ons Vader gebruik te word.

Mag ons as Gideons en Gideonsvroue altyd onthou om voor 'n plasing ons Vader te vra om ons vandag te gebruik om iemand se lewe aan te raak.

## **Heidie van den Berg**

Krugersdorptak



# *Om 'n groot vis te*

## **VANG IN MAURITIUS**

Tydens ons wittebrood was ek en Michelle op 'n dagtoer toe ons by 'n tempel uitkom waar 'n beeld van die hoogste Hindoe-afgod buite Indië gehuisves word.

Ons besluit om nie in te gaan nie maar om eerder buite in die bussie te wag. Terwyl ons iets drink, sien ek die busdrywer eenkant staan.

Ek gaan toe na hom toe en sê: "Vra jy nie hoekom ons nie in die tempel ingaan nie? Die rede is omdat ons in Jesus Christus glo, wie alles wat ons nodig het om gered te word reeds aan die kruis vir ons gedoen het."

Op daardie oomblik sluit nog 'n drywer by ons aan, maar ek gaan voort: "Die groot vraag is: waar gaan jy heen as jy doodgaan?"

Hy antwoord toe dat niemand dit kan weet nie. Ek sê dat ons Christene weet, omdat die Bybel sê dat Jesus vir ons plek gereed gemaak het en wanneer ons doodgaan, sal ons saam met Hom in die hemel wees. Dit is wat ek glo en het sekerheid daarvan.

Hulle sê dat hulle wel Bybels het, maar net die Ou Testament. Ek bied toe aan om vir hulle Engelse Nuwe Testamente te gee, waartoe hulle ingestem het. Ek gaan haal toe twee Engelse en twee Franse PWT'e by Michelle in die bussie. Toe ek by die drywers kom, het 'n derde persoon by hulle aangesluit. Ek gee toe die twee Franse PWT'e aan die eerste twee en 'n Engelse PWT aan die nuweling. Ek maak nog 'n grappie deur vir hom te sê dat hy die Engelse een kry omdat hy meer Engels lyk.

Die manne lag en een sê: "Hy lyk meer Engels, want hy kom van Engeland af!" Ek kon egter geen verskil tussen die drie se gelaatstrekke sien nie.

Die Engelse persoon vra toe waaraan ek glo en ek antwoord dat ek in Jesus Christus glo.

Hy skud toe my hand en sê dat hy ook 'n Christen is. Ons drywer vra toe of hy eerder 'n Engelse Bybel kan kry. Die Engelse drywer gee toe sy Bybel vir hom, waarop hy ons bedank en sê dat hy die Bybel met sy seun gaan deel. Toe die tweede drywer vertrek, vertel ons drywer dat hy elke oggend en aand bid.

Ek vra hom toe: "Wie is die God tot wie jy bid?"

Hy antwoord: "Ewige God."

Ek sê toe vir hom: "Sy Naam is Jesus Christus. Leer Hom beter ken in hierdie Bybel."

Hy antwoord dat dit goed is om die Bybel te ontvang, want, soos hy sê, hy vloek baie. Ek verseker hom dat Jesus hom net soos hy is aanvaar en lees vir hom Matteus 11:28 (AFR83):

**"Kom na My toe, almal wat moeg en belas is,  
en Ek sal julle rus gee."**

Daarna vra ek of hy Jesus wil aanvaar, en hy stem toe. Net daar vorm ons 'n groepie van drie manne wat hande vashou en ek lei hom in die eenvoudige, maar kragtige sondaargebed.

Die vreugde wat ek beleef het op die voorstoep van 'n Hindoe-tempel was 'n belewenis waarvoor ek die Here prys.

Aan Hom al die eer!

**Derrick Kuun**  
Boksburgtak

# INTRODUCTION

Since 1950, members of The Gideons International in South Africa have been dedicated to spreading the Good News. The Gideons International is a worldwide interdenominational organization of Christian business and professional men and their wives who live out their calling through the distribution of God's Word. Since its founding in 1899, Bibles and New Testaments have been distributed in nearly 200 countries, with the only objective of introducing people to Jesus Christ. This testimony booklet celebrates

75 years of God's faithfulness and reminds us of the countless lives touched by the ministry's core work: Winning souls for Jesus Christ.

Each story in this booklet highlights the profound impact of individual acts of faith and obedience. From a Muslim teacher embracing Christianity in a classroom to a man in prison finding salvation, these testimonies highlight the power of God's Word to transform lives. As 2 Corinthians 5:17 reminds us, **"Therefore, if anyone is in Christ, he is a new creation. The old has**

**passed away; behold, the new has come”** (ESV). These accounts serve as a powerful reminder that every Bible distributed and every personal conversation can lead to a miraculous encounter with Jesus, strengthening our calling to be “Still Standing, Serving, and Blessed.”

If you, as the reader, would like to get involved in any way or request more information, you are welcome to contact The Gideons International in South Africa as indicated on the back of this booklet.

# Contents

- 56 That's what Christmas is all about
- 57 A miracle in the classroom - *Elmarie du Plessis*
- 58 Spreading the message of faith - *Kuben Moodley*
- 59 Thank your Lord, for taking care of me - *Ettorina Stoop*
- 60 George disaster - Scripture placement - *Pierre le Grange*
- 61 Bullet stopped by Bible
- 62 Be obedient and available - *Sunette le Grange*
- 63 Journey to eternal life - *Shaun Makgetla*
- 64 The Word and a miracle - a Bible, placed by The Gideons, next to a hospital bed
- 66 General Jorge Da Cronha Vungulipi - *Christo Fourie*
- 67 Be willing to serve and be available - *Sarieta Wentzel*
- 68 A beautiful book - *Kuben Moodley*
- 69 Blessed placement - *Peet Van Der Merwe*
- 70 The old things have passed - *Johan Boshoff*
- 72 Testimony: Da Gama police cells - *Oscar Ehrensperger*
- 73 Empower others to win souls - *Sonna Kitching*
- 74 The work of the Holy Spirit - *Peet Van Der Merwe*
- 75 During times of need - *Koers Fourie*
- 76 Faithful in Türkiye
- 77 Testimony of AJ Wohlfahrt 2023 - *A.J. Wohlfahrt*

- 78 Carried by prayer - *Diederik Esterhuizen*
- 80 God is gracious - *James Milson*
- 81 Saved from suicide
- 82 God is faithful - *Johan Bruwer*
- 83 From car guard to church planter - *Corné en Anita de Jager*
- 84 Much more than food - *Anita de Jager*
- 85 God uses us where we are - *Leana Mostert*
- 86 Good news delivered
- 87 Here I am Lord, use me! - *Robert en Louise York*
- 88 ISB 2025 Testimony - *Patience Makiwa*
- 89 Mothersday 2022 - *Esta Putter*
- 90 Praise God for the ISB in South Africa - *John Mannen*
- 91 The Lord always provides... - *Johann en Marguerite Minnaar*
- 92 The answer is prayer - *Kuben Moodley*
- 93 God's goodness in Ghana - *Lieb Venter*
- 94 A pink mistake ... or a divine appointment? - *ISB Umhlanga team*
- 96 Touch someone's life today - *Heidi van den Berg*
- 98 To catch a big fish in Mauritius - *Derrick Kuun*
- 100 A Jesus moment in Portugal - *Awie Thomas*

# *That's what* **CHRISTMAS IS** **ALL ABOUT**

In 2022, the Tygerberg Branch in the Cape Metro area of Region 1 became part of the fraternity in Goodwood, hosting monthly meetings and a weekly prayer event. The demographics of Goodwood have changed significantly – we are a jumble of cultures, which is very exciting.

The SAPS of Goodwood is also actively involved in these events. The Area Director also serves on the Spiritual Crime Prevention Unit of Goodwood SAPS. The SAPS expressed their need for the local Gideons to come and serve them. They are also looking for people who could undergo a police vetting process to serve at Goodwood Prison.

The highlight of the year could be when Gideons have the opportunity to serve the prisoners at 06:00 on Christmas morning. This is a challenge for all the Branches in South Africa. It could be something The Gideons can do all over our country, even if you are on holiday somewhere.

*That's what Christmas is all about: God, Who had compassion on us and gave us His greatest gift. Live this gratitude in the Christmas season! Seize every opportunity to share the Good News of God's love during the Christmas season.*

# *A miracle*

## **IN THE CLASSROOM**

During the recent International Scripture Blitz in KwaZulu-Natal, we entered yet another classroom to distribute New Testaments to every school learner. The principal had permitted us to move from class to class.

In the specific classroom we entered, the teacher was absent. Just as we were about to begin, the teacher arrived. She was dressed in traditional Muslim attire, with only her eyes visible.

Feelings of discouragement rose within us - we expected that she might not allow us into her class. However, to our surprise, she was friendly and permitted us to hand out a Testament to each child.

The Gideon began his presentation and pointed out the blue printed pages at the back of the Testament to the learners. Without hesitation, I walked over to the teacher and offered her a Testament as well. While The Gideon discussed the “Way of Salvation” at the back of the Testament with the learners, I did the same with her. She took the Testament in her hands and followed along with me through the blue pages.

After the presentation, the learners were invited to pray the “Sinner’s Prayer” out loud, and to my astonishment, the Muslim teacher joined in, praying it out loud along with them. I opened my eyes (during the prayer) to make sure I was hearing correctly... and yes, she prayed the entire prayer along with us!

Thank You, Jesus! Thank you for this miracle!

**Elmarie du Plessis**  
Ghaap Branch



# *Spreading the*

# **MESSAGE OF FAITH**

My wife, Jennifer, and I recently had the wonderful opportunity to visit Egypt. This voyage marked our maiden international journey as Gideons, and we were filled with a mixture of excitement and apprehension. Armed with unwavering faith in the scripture of Matthew 28:19, which instructs us to “go and make disciples of all nations”, and equipped with Personal Workers’ Testaments (PWTs), we eagerly embarked on our adventure.

We learned that approximately 20% of the Egyptian population shares our faith, and there was a profound sense of connection when we shared a PWT with someone in their own language, in their homeland. I conveniently recorded all the PWT placements on the GideonsGO App, and I practised the skills I had acquired from the Gideon Conversations course.

By the end of our trip, we had placed 47 PWTs, which were available in English, Arabic, French, and even Chinese. We had exhausted the amount of PWTs, so we began sharing the Gideon Bible App. Each person who downloaded the app experienced a similar and joyful reaction when they heard the Bible in their native language.

We give all praise and glory to God for opening doors and making this a truly rewarding and unforgettable journey, fulfilling the mission of The Gideons and spreading the message of faith across language and cultural barriers.

**Kuben Moodley**  
Randburg Branch

# *Thank you Lord,* **FOR TAKING CARE OF ME**

The Colesberg Branch visited our school for the yearly Bible placement. After The Gideons left, the Grade 8 learners stayed in my class for two periods, too engaged with their new Bibles for me to teach. They eagerly asked for different verses and spent time reading, and I didn't mind at all – at least they were exploring their new gift.

Our school includes learners of various faiths, including Muslim students. I openly pray when school begins, over the food they receive, and at the end of each day. They know I am unashamed to be a Christian. Reflecting on my life, I see how God has protected me in countless situations. When I look back, I see only one set of footprints.

Thank you, Lord, for taking care of me. What an honour to work for our Lord Jesus. It is very special.

**Ettorina Stoop**

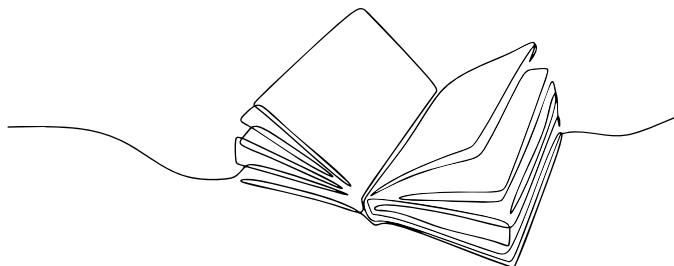

# *George disaster*

## **SCRIPTURE PLACEMENT**

The Bible placement at the scene of the building disaster in George after the it imploded on 6 May 2024, took place as planned. The circumstances were morbid. This was a big challenge because it was difficult to identify the bodies. It caused great uncertainty and trauma for families every time a body was found. We had the opportunity to pray with family members in groups and handed New Testaments to them. Bongani, the brother of a trapped worker, gave his heart to Jesus, praise the Lord. We were also able to pray with others afterwards, including the team that supports families. We prayed with the Support Coordinator of the rescue workers and his team, who provided comprehensive support, ranging from food to trauma counselling.

We were also able to provide them with spiritual food by placing New Testaments. We distributed a total of 280 Testaments in five languages. To Father all the Glory!

**Pierre le Grange**

Mossel Bay Branch

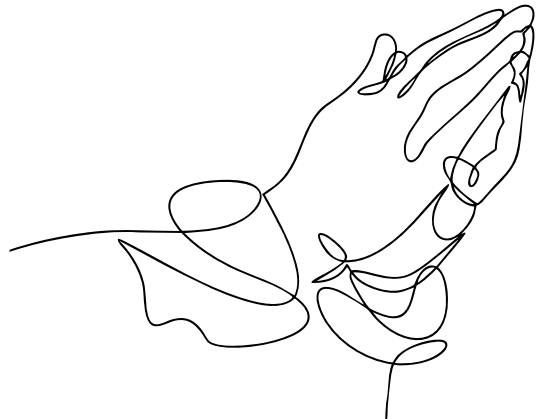

# *Bullet stopped*

## **BY BIBLE**

In 1899, a man realised that all of us needed God's Word, and in 1809, they began to place Bibles. This is how The Gideons organisation came into being.

At the beginning of my military service, I also received a red Bible from The Gideons.

Today, Gideons are active in 199 countries, men and women who freely give their time and resources to help people around the world discover God's love by distributing Bibles.

An Englishman named Frederick Peil was a butcher who joined the army in 1917 to fight in World War I. What he is known for is that he always carried a small Bible in his upper pocket. One day, while they were engaged in an attack, a German machine-gun bullet hit him right on the left pocket of his shirt, where his Bible was.

The bullet was stopped by the Bible and most likely saved Frederick's life. Literally!

May we all be serious about our calling, making sure what our gifts are and where the Father wants us to use them. May we live in the world in such a way that many others are spared the bullets of life.

With recognition to Gerjo Ben – placed on social media.

*Be obedient*

## **AND AVAILABLE**

I was taking care of my grandson, whilst my daughter started working again, and one day went for a walk with him in the garden.

The gardener was working in the vegetable patch and I chatted to him. The Holy Spirit prompted me to ask him whether he wanted a Testament. The look of joy and happiness when I gave him his own copy of the Word will always remain with me. David is another soul won for the Kingdom.

May we be found to be diligent in our calling to spread the Good News.

**Sunette le Grange**  
Mossel Bay Branch

# *Journey to*

## **ETERNAL LIFE**

Ben Fourie, Guston Isaacs, and I shared the Gospel and distributed Bibles to the inmates of the prison. I shared my testimony openly with all the inmates, describing how my life transformed from misery to hope after receiving Christ.

I spoke of near-death experiences due to gang violence and substance abuse, and how God completely renewed my life when I surrendered to Him. Everyone listened to me as if they could visualise what I had gone through. Among them was Whitey, a man whose life was forever changed that day.

With tears in his eyes, Whitey stepped forward, along with others, surrendering their lives to Jesus Christ. They openly confessed their sins and accepted Christ as their Lord and Saviour. The transformation was palpable.

Just two days later, Whitey passed away, leaving behind a legacy of faith and redemption. Though his time with us was brief, his decision had eternal implications.

We rejoice, knowing Whitey is now in the presence of his Saviour, free from pain and suffering. His story inspires us to share the Gospel with urgency and compassion.

To God be the glory for the miraculous transformation in Whitey's life.

**Shaun Makgetla**

Welkom Branch

# *The Word and a miracle -* **A BIBLE, PLACED BY THE GIDEONS, NEXT TO A HOSPITAL BED**

On the night of my birth, I was born paralysed on one side of my body. My mother, who was 42 at the time, was devastated that her baby had been born this way. Early the next morning, she was told that both of us would have to fly to the neurological division of a hospital in the city.

That night, my mom reached for the Bible, placed by The Gideons, beside her hospital bed and she asked God a very specific question: “What will become of this child?”

As she opened the Bible, her eyes fell upon the prophecy of John the Baptist’s birth. In Luke 1:66 (ESV), she reads:

**“‘What then will this child be?’ For the hand of the Lord was with him.”**

Through this verse, my mom’s faith increased; she thanked God, closed the Bible, and was at peace.

Early the next morning, a red-haired nurse brought me to my mother, saying, “Look, a miracle – your baby is perfectly fine and her limbs are moving and responding!”

We thank The Gideons International in South Africa, who faithfully distribute Bibles in hospitals.

Later in life, I was in a car accident, and for the first time, I had to get X-rays of my back. In the ER, the doctor asked when I'd had spinal fusion surgery. When I replied, I had not, he asked my husband.

My husband replied, "Lift her shirt, there are no surgical scars." The doctor did so, clearly puzzled, and said, "Your X-rays show a spinal operation."

I remembered my birth story – my spine bears witness to work done without any surgical mark. I thank Jesus for hearing my mother's cry, and I thank You, Abba Father, Lord Jesus, and Holy Spirit, for all the miracles You have done, are doing, and will do for all time.

**Anonymous**

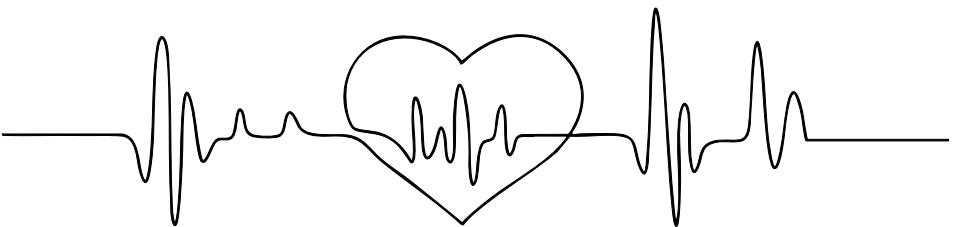

# *General* **JORGE DA CRONHA VUNGULIPI**

At 15, he was a sniper and a merciless executor – killing Christians.

The most radical and dramatic act he did was when he executed an evangelical pastor. Shortly before his execution, this pastor asked General Vungulipi if he could pray for him. After prayer, he gave General Vungulipi a Bible from The Gideons and asked him to read Romans 10:20. So he read the passage, but it made no sense to him. He executed the pastor.

General Vungulipi was terribly upset as he thought about the pastor's prayer before he executed him. The pastor prayed, "Father, forgive this young man, because he does not know what he is doing." After that night, the General felt a great fear in him and from then on, for many years, he always carried this little Bible with him.

The General became very ill and accepted the Lord Jesus Christ in a church. The pastor helped him to write his name in the back of the little Gideon Testament.

In 2011, he and his wife joined The Gideon ministry, and he was a Gideon till the day of his death in 2014. As Gideon and the Chief Officer of Angola, he attested to his faith by giving Bibles to his colleagues and the soldiers. He helped them to receive Jesus Christ as their Lord and Saviour – a legacy of General Vungulipi.

**Christo Fourie**  
Harrismith Branch

*Be willing to serve*

## **AND BE AVAILABLE**

I handed a PWT to a car guard at a supermarket in Bethlehem after my husband, Chris, had passed on. As a widow, it was quite difficult for me to attend meetings as I missed him too much when I observed all the other happy couples. I was in doubt whether I should continue to be part of The Gideons without my husband.

I asked the Lord to please show me what to do... and I waited. After a while, I went to the same supermarket and I heard a voice calling, and when I turned around, a car guard was running towards me, waving something in his hand. When he reached me, he said to me: "Madam, it was you, it was you who gave me this Bible, and now I know Jesus."

The Lord answered my prayers, I even forgot what I wanted to buy, got into my car, and thanked the Lord for His faithfulness. The Lord used this man with his PWT to show me that I should continue in this ministry.

And now, nearly sixteen years later, God can still use a modest widow in His service. He can use anybody – just be willing and available to serve Him. I honour Him for His grace.

**Sarieta Wentzel**

Oranje Branch

# *A beautiful* **BOOK**

Yesterday, I went for my post-operation consultation. Praise the Lord that all is well. I am healing nicely.

While waiting for the doctor, who is a non-believer, I picked up a bilingual Bible, placed by The Gideons, in the waiting room. I smiled to myself, knowing that a fellow Gideon was here to spread the good Word.

“Beautiful book, isn’t it?” said a woman from across the table. It started a conversation about Christ, and I believe that other people in the waiting room heard the Word in some form.

An awesome moment was created just by picking up a Gideon Bible.

Thank you, Lord, for The Gideons who have walked before me.

**Kuben Moodley**  
Randburg Branch

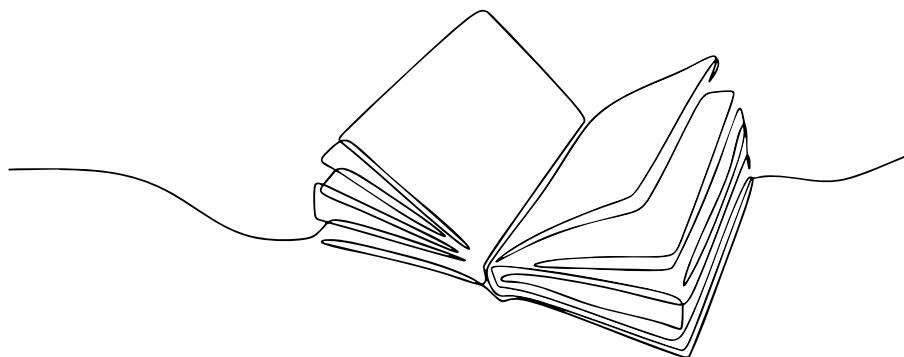

*Blessed*

## **PLACEMENT**

The head teacher of the Grade 8 students accompanied and introduced me to the 30 learners, after which the Bibles were shared. I explained who I was and what value the Bible would bring to their lives. Also, the students were told that the intention of the Word will only become clear once it is read. I also shared God's plan of salvation with them, I prayed for them and asked them to commit to reading the Bible regularly.

The teacher requested I share the same message with the "problem class". I sensed at once that these students were indeed "different". Surprisingly, they quieted down immediately and listened to me. I had the same response from the problem class as with the first class.

The headmaster and the Grade 8 head teacher thanked me and asked if I could give them seven Testaments for the Grade 12 learners who do not have a Bible. He asked if he could call on me if he needs spiritual help at the school. I committed myself to being available to them as needed.

We pray that 60 lives will be changed by the Word of God, which will never return to Him void.

To God be all the glory.

**Peet Van Der Merwe**  
Randburg Branch

# *The old things* **HAVE PASSED**

“My name is Cheslin Janse. I am originally from George. I lived with foster parents because my biological mother was too young to take care of me. My foster parents accepted me as their own, and I called them Mom and Dad. I walked to the New Dawn Park Primary School every day.

My foster father had a drinking problem, and that is why my foster mother left. Later, my foster father got himself a young girl. She made food for us and looked after me whenever my foster father worked. She also left.

One evening, my foster father prepared a meal for us which we enjoyed together. I put on my pyjamas because I liked to sleep at his feet. The next morning, I woke up and found that my father had committed suicide.

My life was not the same again. I had to go and stay with my biological mother and stepfather. I still went to the same school every day. The one person I loved so much is suddenly gone. Not that I didn't love my own mother, but I was just thinking about myself, about the pain I was experiencing.

I went to school until Grade 5, and I started smoking marijuana and using pills and tik. At the age of 17, I became involved in gangs, started stealing and lying, and later I robbed school children. These were choices I made because of the pain in my life.

I've been to reform school a few times, but I only committed more crimes such as truck hijackings, human trafficking and house robberies. They caught me and I was jailed for eight years. I was in a gang and in room three in prison, where I had authority as a gang member. I didn't sleep for months, for fear that someone was going to murder me.

We were moved to room one, where Uncle Gellie came to call me for an appointment with Uncle Johan Boshoff. On that day, something wonderful happened: a feeling inside me that I cannot describe, but today I can say with an open heart that it was the Lord my God who spoke to me. Today I live like a new person, even though I am still in prison, because the chains of sin are broken over my life. I say thank you to the Lord and also to Uncle Johan, who was used by the Lord to reach me. The Lord says in 2 Corinthians 5:17 (ESV):

**“Therefore, if anyone is in Christ, he is a new creation. The old has passed away; behold, the new has come.”**

The most amazing thing is that my family is in touch with me again. The Lord wants to give you what the world cannot give you, and that is Eternal Life if you accept Him. That’s my testimony.”

**Johan Boshoff**  
Mossel Bay Branch

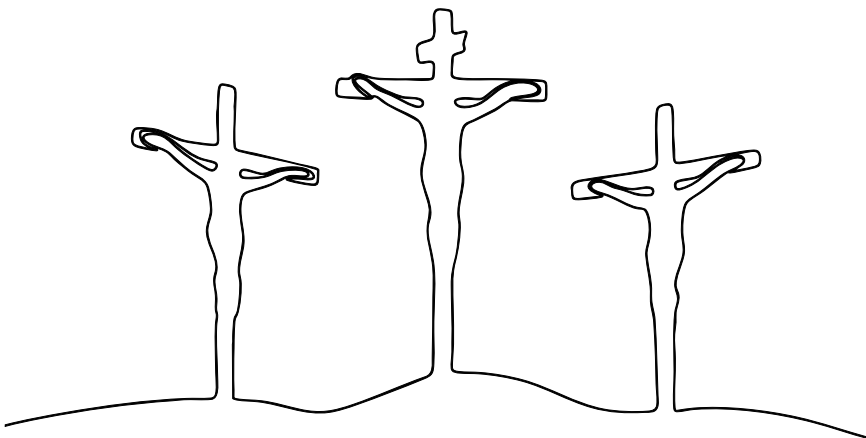

# *Testimony:* **DA GAMA** **POLICE CELLS**

A South African police colonel gave The Gideons permission by the grace of the Lord to visit the police cells at Da Gama police station on Sunday afternoons between 14:00 and 16:00.

We were eight people in our group, including two Gideons' Wives, who were tasked to place Bibles with the female inmates. I spoke to 23 foreign prisoners in one cell. I explained the way of salvation to them and handed a copy of the New Testament to each of them.

It was great to visit that cell again the following Sunday and find the whole cell of all 23 prisoners still there.

As they had received Good News already, I could just elaborate on that. Then, I challenged them to decide for Christ. Many of them said they'd been reading the Testament during that week, so the Holy Spirit was already at work. I then invited them to pray with me to receive Christ and dedicate their lives to Him, which they all did.

What a Mighty God we serve! To God be the Glory.

**Oscar Ehrensperger**  
Mossel Bay Branch

# *Empower others* **TO WIN SOULS**

I'd also like to share a testimony from when my husband was admitted to hospital and the lady at reception went out of her way to assist us. I wanted to show my gratitude by offering her a cup of coffee, but she declined. I gave her a Bible, and she was genuinely surprised that someone would give her a Bible. Yes, winning souls for Jesus is at our core at The Gideons, but we sometimes forget to give others a tool with which they can work. She sees many patients daily when they are admitted.

I explained to her that at the front of the Bible, she could find prayers and specific verses to offer encouragement in various circumstances.

I suggested she could jot down relevant Bible verses and share them with patients who need encouragement. She was amazed to discover that she had a unique opportunity to win souls for Jesus through this simple act. She promised to keep the Bible on her desk.

This experience showed me another way to win souls for Jesus through our Gideons' PWT. It's also about empowering others who have a genuine passion for Jesus, helping people and touching lives.

**Sonna Kitching**

Queenstown Branch

## *The work*

# OF THE HOLY SPIRIT

My wife, Diana, did a Bible placement at a home for Alzheimer's and Dementia patients. After the placement, the sister in charge asked her if she did not know someone who could serve these people spiritually on an ongoing basis. The "church" had indicated that they could not. Diana then nominated me for this task. I went to see them and agreed to visit them on Wednesday afternoons.

I remember that on my way to the first visit, I pulled over to the side of the road to pray and ask the Lord for wisdom, because I felt so incompetent. The Lord spoke to me in my spirit and said I should talk to the spirit of the people. I asked the Holy Spirit to enable communication with their spirit so that they could understand. I paid close attention to their reactions and could observe that there was definitely a positive reaction in the spirit.

The sister mentioned that there were remarkable reactions. She said that "something" was just different and asked me to continue with the ministry. I explained to her what I was praying for and that God was doing something great and teaching me how to communicate meaningfully in this field.

God loves these patients just as much as He loves the rest of the world. He gave his Son to lay down his life for them as well. I encouraged these precious people by telling them that they can change the world through prayer. They can still enter into spiritual warfare.

To Him be all the glory!

**Peet van der Merwe**  
Randburg Branch

*During*

## **TIMES OF NEED**

“Out of my distress I called on the Lord; the Lord answered me and set me free” (Psalm 118:5 ESV).

The Branch Leader of Harrismith, Cobus de Jager and his family were diagnosed with the Coronavirus in April 2020. While he was extremely critical in the hospital, several Gideons and Gideons’ Wives faithfully prayed for him. Cobus and Mary’s testimony is that they realised how blessed they were to be part of this ministry. He says that they received calls and text messages from Gideons all over the country. He never realised how swift and powerful the Gideons’ prayer ministry truly is. It meant a great deal to them as a family in a time of great crisis. The verse that stays with him all the time was:

“For whoever has despised the day of small things shall rejoice” (Zechariah 4:10a ESV).

He would never see the ministry of The Gideons or Branch meetings the same way again. He no longer takes the value of the Branch’s unity, inspiration, and planning for granted, and will never underestimate their importance.

Thank you to everyone who faithfully prayed for him, Mary and their children.

They endured many storms, and Mary lost her father to the Coronavirus. At the time, she was still ill and couldn’t attend his funeral, which took place in the Cape.

Cobus was still on oxygen for some time, but we praise the Lord for the complete healing of the family.

**Koers Fourie**

Harrismith Branch

# *Faithful* **IN TÜRKIYE**

This testimony was given by Esmari and Paul, missionaries residing in Somerset West. They went on a prayer tour in 2005 to Turkiye.

In the hotel in Kuşadası, they met a lady called Malech, which means angel. Malech said she wanted to share her testimony with them.

Her father was on a business trip to Istanbul, and he packed all the free items, such as soap, shampoo, coffee, and a book. When he got home and unpacked, he realised that the book he had taken was a Bible. So, he tossed it into the wastebasket.

Without him knowing it, his wife collected the Bible from the wastebasket and started reading it. She accepted Jesus Christ through the Word as her personal Saviour and was saved. She told her husband the Good News, but he thought she was crazy, so he refused to sleep in the same room as her. He allowed his daughter, Malech, to move into the room with him.

One night, they woke up with a light shining in their room. Whilst they were pondering about the light, an angel appeared to them and said: "Do not be afraid. I am an angel sent by God. Your wife is not crazy. She has found the Lord Jesus Christ, and you must listen to what she has to say."

After this incident, the father and Malech got saved too, and then, the whole village turned to Jesus Christ and accepted Him as their personal Saviour.

All because one Gideon was faithful and placed a Bible in a hotel room.

# *Testimony of*

## **AJ WOHLFART 2023**

On 5 February 2023, Bernie de Clerk, a fellow Gideon, and I had the privilege of distributing Testaments at the Krugersdorp prison cells.

At the last cell, I mentioned to the prisoners that we have Good News for them, and this Good News is in the Testament. I then challenged them to read the last page and make an eternal decision. One prisoner stepped closer and said he had found a Testament in their cell the day before and had since given his heart to the Lord. Isaac said he was now a born-again Christian. He then exchanged his Testament for a new one so that I can share his testimony with everyone in future.

Don't underestimate the power of a Testament: it is given to someone who might just be the tool to get the message out to someone else.

**A J Wohlfahrt**

Krugersdorp Branch

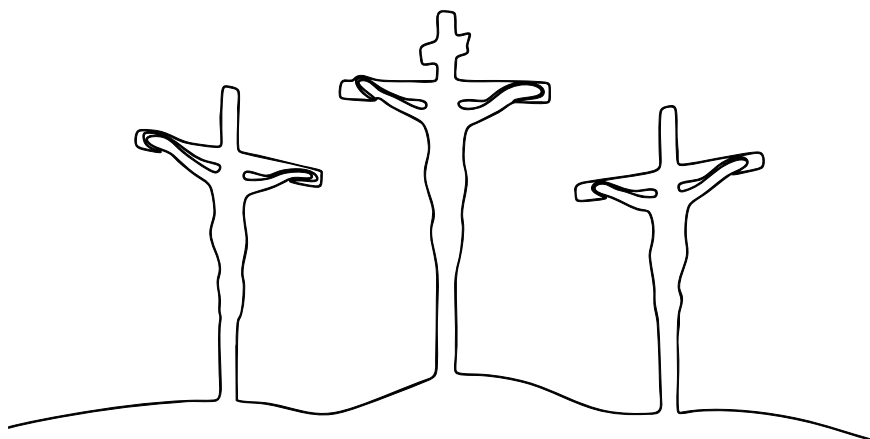

*Carried*

## **BY PRAYER**

I would like to share something from my personal experience during the COVID pandemic in the winter of 2020/21, specifically about prayer, and how it carries us through difficult times.

I fell ill and tested positive for COVID-19. When my oxygen levels began to drop, I was admitted to hospital. After a week in the Medi-Clinic in Thabazimbi, where my lungs were steadily deteriorating, I was airlifted to Welkom, the only place with an available ICU bed and ventilator.

I was sedated before the flight and have no memory of it. In the ICU in Welkom, I remained on a ventilator for a full week. I was seriously ill. The doctor told my wife, Ané, that my chances of survival were one in three. The ICU statistics at that time were grim.

Believers started praying for me and my family. And we could truly feel it. I never experienced panic or breathing distress, and Ané and the children also felt a deep peace, despite the challenges they faced. We genuinely felt that God was carrying us, and that believers were lifting us up to Him in earnest prayer.

While I was under sedation, I had a dream: Ané and I were walking through the mall in Thabazimbi. I was wearing an oxygen mask, which I still needed in the dream. When she briefly stepped into another shop, my oxygen ran out. I collapsed to the ground and knew – this was the end. I tried to call for her, but she couldn't hear me because I was unconscious. That's where the dream ended.

After I was discharged from the hospital and started to recover, Ané told me that one night she had a strong, urgent feeling to pray for me, specifically.

To place her hands on my chest in the spirit and pray for healing. This was unusual for her, as we are members of the Dutch Reformed Church, but she obeyed.

Later, we heard from a friend in Harrismith who had the same experience: one evening, he felt compelled to pray for me and lay hands on me in the spirit. He even said he felt his hands grow warm during the prayer. Still later, we heard from a family member in the Cape who had the exact same experience, at the same time.

I believe it was at that very moment in my dream, when I cried out in the spirit, that the Lord moved people to pray for me.

Prayer makes a difference. When the Holy Spirit prompts you to pray, listen. Don't delay or doubt. Pray without ceasing.

**Diederik Esterhuizen**

Thabazimbi Branch

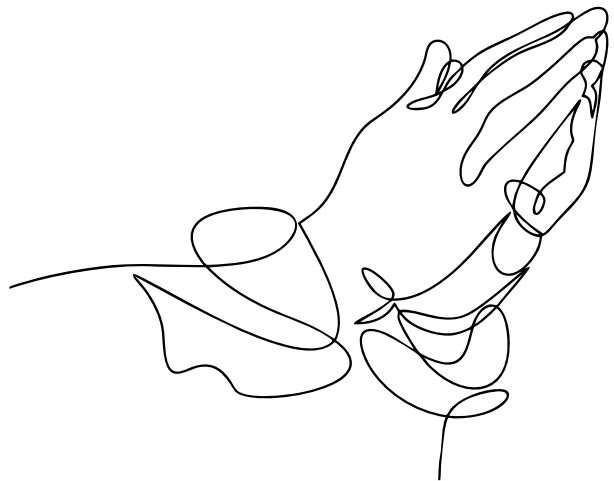

*God is*

# **GRACIOUS**

I witnessed many acts of grace during the Durban KwaZulu Natal ISB 2025. I believe they are stepping stones to the salvation of many.

On arriving at Johannesburg airport, a Venda porter took me to the domestic flight desk. Having exhausted my supply of pocket Testaments, I took a used Bible from my case and prayed for Sachimo, that he would receive revelation from Jesus, whom he said he loved.

Our days started early with a prayer meeting, breakfast and then on to the schools. Many were visited, and many Testaments were shared. It was a blessing to experience the need for the Word and the faithfulness of the Lord. My experiences will be with me for a long time.

I had the privilege of sharing 18 Personal Workers' Testaments in the area where we were staying. A young man, Rasheem, had attended a church where a Gideon presentation had been done. His heart had been touched, and he wished to receive a Testament.

God is gracious in His goodness and faithfulness.

To God be the Glory.

**James Milson**

Australian ISB member

# *Saved from* **SUICIDE**

A heart-warming chain of events unfolded, demonstrating the incredible impact of a *Friends'* Testament when a grandmother of our church expressed her desire for one of the small Bibles that were distributed to the children during Sunday school. I promised to arrange an Afrikaans Bible for her.

Her son-in-law visited our store, and I asked him to give the Bible to the grandmother. The young man revealed that the small Bible was for his youngest child, who did not receive a Bible at Sunday school.

This testimony traces back to Bibles sent to a *Friend of Gideons*, who recognised the opportunity to share God's Word with children. The grandmother's grandchildren usually attended a different church, but on that particular Sunday, her eldest grandson accompanied her.

The distribution of the Bibles occurred on that Sunday. The young boy, thrilled with his pocket-sized Bible, carried it daily in his school bag.

The young boy's friend confided in him about contemplating suicide. The young boy retrieved his small Bible, recalling advice on where to find help in times of crisis. He found relevant verses and shared them with his friend. These verses made a profound impact on his friend, who reconsidered and abandoned any suicide attempts.

The journey of that little Bible culminated in a moment where its verses held life-altering meaning for someone in desperate need.

We praise the Lord for orchestrating these events. While we may not comprehend the path of a little Bible, God knows exactly who needs it.

With gratitude,  
**A Gideon**

*God is*

# **FAITHFUL**

In the parking area outside our Pick & Pay centre here in George, I met a young car guard called Bradley. He is about 35 years old, very neat and an Englishman at that.

I had a R10 note to give him, but I invited him to my bakkie and told him that I could offer him much more than the R10 if he wanted to listen. So, I ministered to him with an English PWT and then explained to him the verses and the way to salvation. I drove up to him again the next day and prayed for him, again.

Two weeks later, I was at a wholesaler that sells construction equipment. Suddenly, a man wearing construction overalls approached me. I didn't recognise him at first, but it was Bradley. He excitedly told me that Jesus had changed his whole life since he received the Bible and made things right with God. In the same parking area, a builder offered him a good job as a foreman on a construction site, with good pay.

All glory to God for his great faithfulness.

**Johan Bruwer**

George Branch

*From car guard*

## **TO CHURCH PLANTER**

Pastor John contacted us from Tanzania, where he is currently working among the lost people, locally and in the Democratic Republic of Congo. He made contact with Gideons from Australia, who were on safari and had spent time with them.

The visiting Gideons attended some of his services and blessed him with funds. He still promotes The Gideons as the ministry that led him to Jesus, and he encourages every believer to thank the Lord for their work – because, in some way, we all benefit from the impact of the ministry of The Gideons.

The number of congregation members is growing daily. Pastor John was a car guard at Checkers Hyperama, where he gave his heart to the Lord after receiving a Personal Workers Testament from a Gideons' Wife. He has left South Africa to work among the lost in Africa and is now on his way to Burundi.

To God be the glory!

**Corné en Anita de Jager**  
Bethlehem Branch

# *Much more* **THAN FOOD**

After a successful hospital placement in Bethlehem on 14 April 2017, we stopped in a parking lot to buy takeaway meals for lunch. While my husband, Corné, was still in the shop, a lady approached me to buy food for her. However, I felt that I would rather give her money; then she could buy food for herself and possibly save money for other necessities. I took out a Personal Workers' Testament to give to her along with the money.

When she saw the Testament, her eyes immediately filled with tears. She asked me if I could help her give her heart to the Lord. It was my privilege to explain to her the way of salvation there in the parking lot and to also show her the passages in the front of the Testament. I could lead her in prayer to commit her life to the Lord. It is my prayer that she was sincere when she had prayed to accept the Lord. I explained to her that accepting the Lord as her Saviour was not a guarantee that our problems would all go away, but that He was now there to help her through difficult times. I also explained to her that He would provide, perhaps not as she wants or when she wants, but in God's time and manner.

And so, on that day, Lindsey received much more than food.

To God be the glory.

**Anita De Jager**  
Bethlehem Branch

*God uses us*

## **WHERE WE ARE**

I am a physiotherapist and treated a young girl who was in a lot of pain.

As the conversation progressed, I shared my faith perspective with her. She left there with the promise that she would come again for treatment.

To my surprise, she did make an appointment and came. Throughout the treatment, I shared with her the path of salvation. She decided right there that she wanted to give her life for the Lord – without me even asking her! So I left her on the bed and went to get a pink PWT in the car and prayed with her.

Praise the Lord!

**Leana Mostert**

Capricorn North Branch

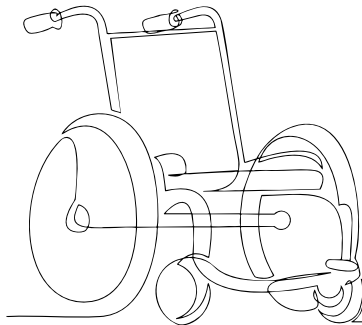

*Good*

# NEWS DELIVERED

A Pastor, who asked to stay anonymous, is a *Friend of Gideons*.

In this capacity, he receives three New Testaments every three months via a courier. When the Testaments were delivered in July, the Spirit prompted him to ask the driver of the courier company if he would like a Bible. The result was that a new soul was led to Christ, and she prayed the sinner's prayer with the pastor.

The angels rejoice in a sinner who has become a new person in Christ.

All glory to God!

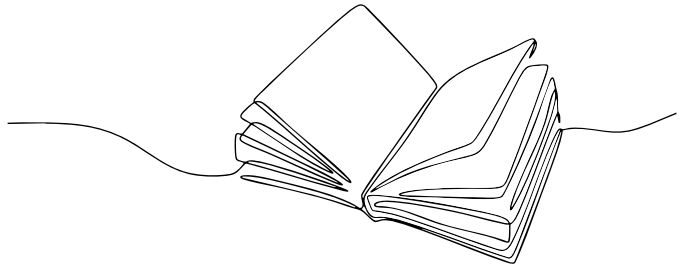

*Here I am Lord,*

## **USE ME!**

To go on the Butterworth Bible blitz and sow into the Kingdom together with your wife and other close friends who love our Father and lost souls, is an extraordinary blessing. We were received with open arms at all the schools and our team distributed over 3 400 Testaments in the two days.

In most places, we had to drive over bad roads to get to schools where the dilapidated classrooms had no coloured posters. There were only bare walls and even some broken school benches where smiling children sat happily three by three on two-seat benches. All were waiting eagerly with open hands and hearts for their own Testament.

The blessing we experienced was complemented by the beautiful scenery created by our God. We visited places we would never get to go if it weren't for the wonderful ministry of The Gideons. It is truly a great privilege to serve in this ministry!

May God be glorified and His kingdom be expanded with every Testament that was distributed during the blitzes.

My prayer that I would like everyone to pray is: "Here I am, Lord, use me! Amen."

**Robert and Louise York**  
Ghaap Branch

*ISB 2025*

# TESTIMONY

I went to my first KZN Bible blitz.

Monday, the first day, was awesome. The first school was the biggest of all. There were 1700 students, and they were having a surprise birthday celebration for their principal. We also visited a school in Richmond, the Pietermaritzburg Rural School. The principal is new and is also a pastor. Since he came to the school, they have had a 100% pass rate. The other school, a Muslim school, allowed us in after a struggle. They have a Christian fellowship group where we shared the Word. They were very appreciative.

I learned how to prepare for future blitzes. I also met new people in The Gideons. I definitely improved in my approach to multicultural schools with various languages. Meeting people with diverse cultural backgrounds is a challenge. But with God, all things are possible.

**Patience Makiwa**

Johannesburg-South Branch

# *Mothers Day*

## **2022**

We have a teacher in Vryburg who does a wonderful job among the poor community there. His passion is to make a difference in these children's lives.

He began to read the Bible and pray with them. He also discovered a lot of talent amidst this group. The teacher's dedication has led to one of the children winning both a Silver and a Bronze medal at the SA Schools Athletics this year.

I had the privilege of handing out PWTs with him as Mother's Day gifts to these families, with the request: read it with your children.

The children were so excited about the Testaments as gifts to their parents. In most cases, they have never had the privilege of being able to give mom or grandma something for Mother's Day.

Pray with me that these Testaments will really make a difference in the lives of these families.

Jesus' love knows no end. Let's go out and live it so that others can experience His love too.

**Esta Putter**

Vryburg Branch

# *Praise God for the* **ISB IN SOUTH AFRICA**

I praise God for what He did in the South African ISB. God's ways are so much higher than our ways, and what He does is far beyond what we can imagine or think! I thank God for the glimpses He gives us of the amazing things He has done and continues to do. The following verses come to mind:

**“Now to him who is able to do far more abundantly than all that we ask or think, according to the power at work within us, to him be the glory in the church and in Christ Jesus throughout all generations, forever and ever, Amen” (Ephesians 3:20-21 ESV).**

I praise God for turning a 300 000 goal into more than 411 00 Scriptures placed, for 495 personal witness opportunities that we know of, and for 95 church presentations.

I came home so very fired up and encouraged, and I gave God thanks for the results of this ISB, which continue on. May each of you be encouraged and give God thanks for His faithfulness to provide open doors and open hearts to His glory!

**John Mannen**  
USA ISB member

# *The Lord* **ALWAYS** **PROVIDES...**

From previous experience, we have learnt that only English is readily accepted in the big towns because learners cannot read any other language.

Imagine our disappointment when only Zulu and a few English Testaments were available for us to load on Sunday afternoon at the depot in Kokstad. My wife and I were positive as we loaded 4 000 English Testaments to start with. But after the 2 biggest schools on Monday, our English stock was depleted. In fact, we were 2 Testaments short.

We headed back to the depot to restock, only to learn that no more English Testaments were available. So, with Zulu Testaments loaded, we set out. We were welcomed, but met with negative responses at the next two schools. They are not able to read Zulu. We sent out a mayday on the WhatsApp group to help with English Testaments.

We continued to two more schools and a college of about 600 students, with the Zulu Testaments.

As we had no more work in town, we set out to help another team. En route, we received a message from the college to collect the 600 Zulu Testaments as the students could not read Zulu. Devastated, we mentioned this to the team we helped, and were blown away at their response. "We have English Testaments we are about to hand back." We met up and received 1100 English Testaments!

The Lord interceded and provided the exact number of Testaments we needed to complete our task! Glory to God!

**Johann and Marguerite Minnaar**  
Mossel Bay Branch

# *The answer* **IS PRAYER**

I arrived at the school early on a Tuesday morning, so that we could make an appointment to distribute Testaments at the assembly on Thursday. The principal told me that there is a water shortage in the area and he will have to send all the learners home. He added that this situation normally takes three to four days to restore.

We were only scheduled to be in Durban for the week of the ISB blitz. How were we going to do these placements? That afternoon, we prayed with the Durban Gideons. After the prayer session, I noticed a civil servant taking water readings in the road. I asked him about the problem, and he said a pump had malfunctioned, which was now miraculously rectified, and water was immediately restored to the area.

Our Heavenly Father had answered our prayers, and we were able to visit eight schools in the area and place over 3 500 Testaments in the hands of children.

We prayed. God answered and opened doors, so that His Word could be shared. What an awesome God we serve... He who makes the impossible, POSSIBLE.

**Kuben Moodley**  
Randburg Branch

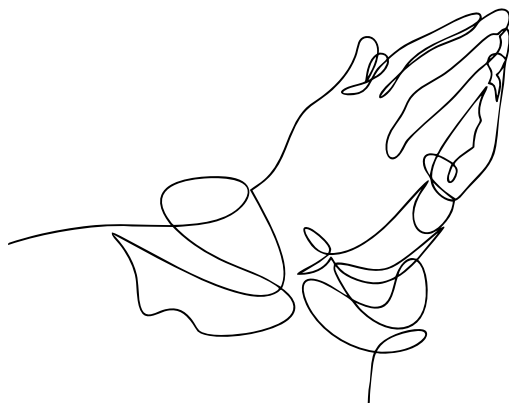

# *God's goodness*

## **IN GHANA**

I've just returned from Ghana, where I worked for a week and a half. I stayed in a hotel and noticed a bilingual Testament in the room. But what touched me most was an encounter with a local man who, according to him, had felt a strong prompting from the Lord that very morning to come to the hotel – the same hotel where I was staying.

He told his wife that he had a deep inner conviction that he needed to go to that specific hotel. And there, he met me. This man started a small bakery and business from scratch. Once a week, he gathers young people, gives them free bread, and then shares the Word of God with them by reading from his Bible.

Fortunately, I had brought a few English PWTs along with me, and I was able to give him five. The man was overwhelmed with joy and sincere gratitude. With tears in his eyes, he explained that he now had six Testaments to use in his ministry among the youth.

For me, it was a true eye-opener about the deeper meaning of the work we do. It reminded me once again: wherever we go, the Lord places us exactly where He can use us. I wondered why I was sent to Ghana apart from the agricultural work I had to do, but this encounter made everything clear.

I share this with you because it is another confirmation of the Lord's goodness and guidance.

**Lieb Venter**

Tsitsikamma Branch

*A pink mistake...*

## **OR A DIVINE APPOINTMENT?**

On Thursday, 8 May, Erik and Ansie Oosthuizen from the Hennops Branch visited the Bible hub to collect Testaments for distribution. They needed English Testaments, but when they arrived, no one was available to assist them. Unfazed, they loaded the boxes themselves, recorded the details, and set off for their placement.

Their destination: a Muslim school where, based on experience, they expected only about a 40% acceptance rate. No presentations are allowed, and previous visits confirmed the limited openness.

But everything changed the moment they opened the boxes – pink Testaments! They had taken the wrong boxes by mistake. Still, there was no turning back now. They had to continue.

Then something remarkable happened...

As the girls caught sight of the pink Testaments, a buzz of excitement spread. Suddenly, it wasn't about religion – it was about colour! All the girls wanted the cute pink Testaments, and the boys? They wanted the blue ones!

One brave boy even walked up to Erik and said, "I want a pink one too." Of course, Erik handed it to him without hesitation.

When they tallied the numbers afterwards, they were stunned: 80% of the learners at that school had accepted a New Testament.

A simple mistake became a divine appointment. Praise the Lord!

May these Testaments find their way into Muslim homes, be read with open hearts, and transform many lives.

**ISB Umhlanga team**



# *Touch someone's*

## **LIFE TODAY**

It is Sunday, 13 April 2025. Gideons and Gideons' Wives from the Krugersdorp Branch arrive at Yusuf Dadoo Hospital. As usual, after praying, we split into groups and entered the hospital.

My husband and I remain and decided that we will observe the placement together today. We move from ward to ward, sharing the Gospel and giving Testaments to the staff.

As we walk through the halls, we hear someone calling to us. We turn around and see a young man. He asks us if we might be able to help him. He was admitted to this hospital because he wanted to commit suicide. Despite the help he receives here, he still thinks about committing suicide.

Cobus replies that we can help him accept Jesus, because Jesus can certainly help him. In John 10:10 (ESV), the Bible says:

**“The thief comes only to steal and kill and destroy. I came that they may have life and have it abundantly.”**

I explain to the young man that there is someone who wants to steal his happiness, his purpose in life and even his life, but that Jesus wants to give him life and that in abundance. To Jesus, he is very important, because He has a purpose for the young man's life.

Together, Cobus and I were able to share the Gospel with this young man.

The young man then asks us if we can help him accept Jesus. Cobus

explained to him that he would pray, and then the young man could repeat what he was praying. Together, they prayed the prayer of deliverance.

It was so beautiful when they said amen, and we could see life in the young man's eyes for the first time and a smile on his face.

What a privilege to be used by our Father.

May we, as Gideons and Gideons' Wives, always remember to ask our Father before a placement to use us to touch someone's life.

**Heidie van den Berg**

Krugersdorp Branch



# *To catch a big fish*

## **IN MAURITIUS**

During our honeymoon, Michelle and I went on a day tour and visited a temple that housed the most important Hindu idol outside of India.

We decided not to enter, but rather to stay on the bus. While we were drinking something, I noticed our bus driver standing outside. I went up to him and said, “You do not ask why we have not entered the temple? The reason is that we believe in Jesus Christ, who did everything we need to be saved on the cross.”

At that moment, a second driver joined us, but I continued, “The most important question is, where do you go when you die?”

He stated that no one could know. I stated that we as Christians know because the Bible says Jesus went to prepare a place for us, and that when we die, we will be with Him in heaven. That is what I believe, and I am sure of it.

They then said that they have Bibles, but only the Old Testament. When I said that I can give them English Testaments, should they be willing to accept, they agreed. I went back to Michelle on the bus to fetch two English and two French PWTs.

Back at the drivers, I saw that a third person joined them. I gave the two French PWTs to the first two men and an English PWT to the new person, joking that I would give the English Testament to him since he appears to be British. They laughed and said, “He looks British because he is from Britain!” I could not see any difference in their facial features.

The English-speaking person asked what my belief is, and I stated that I am a Christian. He shook my hand and said that he was also a Christian.

Our driver asked if he could instead have an English Bible, whereupon the English driver gave his Bible to him. He thanked us and said that he would share the English Bible with his son. When the second driver left, our driver said that he prays every morning and every night.

When asked who the God he prayed to was, he said, “Eternal God.”

I then stated, “His Name is Jesus Christ. Learn more about Him in this Bible.”

He then said that it is good to have the Bible because he curses a lot. I said that Jesus accepted him as he is, and read Matthew 11:28 (ESV) to him:

**“Come to me, all who labour and are heavy laden, and I will give you rest.”**

I then asked if he would accept Jesus in his life, and he answered, yes. Just there, we formed a group of men, holding hands, while I led him in praying the sinner’s prayer.

The joy that I experienced there in front of a Hindu temple was so enriching.

To Him alone be the glory!

**Derrick Kuun**  
Boksburg Branch

# *A Jesus moment*

## **IN PORTUGAL**

Today I experienced a true Jesus moment! On a steep uphill road, we saw an elderly lady with a hunchback resting at a sidewalk café. It was clear that the owner knew her – perhaps he regularly gives her something to eat. A young man came from the café and handed her a cooler bag. She was also carrying a plastic bag full of groceries, and I offered to carry it for her.

But, she refused and responded with a few grand-sounding Portuguese words. I simply took her arm, linked mine with hers, and started walking with her. She laughed and made loud comments! We had no idea what exactly she was exclaiming, but people around us started laughing and made humorous remarks.

I then encouraged her with great enthusiasm in Afrikaans: “Kom oumatjie, jy kan dit maak – ons gaan tot bo!” (Come on, granny, you can do it – we’re going all the way to the top!)

When we reached the crest of the hill, she thanked me warmly. Then I gave her the Bread of Life in her own language. At first, she was hesitant to accept it, but when she saw that it was a Testament, her face lit up with disbelief and gratitude. It moved us deeply!

Who would think that Jesus could use me in a foreign land with a foreign language to glorify His name?

Thank you for my Portuguese PWTs!

**Awie Thomas**

Maskam Branch



# The Gideons International

IN SOUTH AFRICA

P.O. Box 35689, Menlo Park, 0102

Tel: (012) 460 7241/2

Fax: 086 630 8149

Email: [info@gideonssa.org](mailto:info@gideonssa.org)

[www.gideons.co.za](http://www.gideons.co.za)

## Follow us on social media:



The Gideons International in South Africa



The Gideons Intl in SA



@GideonsinternationalSouthAfrica



@GideonsSA



@thegideonsinternationalins4130